



U.S. Department  
of Transportation

**Federal Aviation  
Administration**

# Aviation Science Activities for Elementary Grades

---

Revised 1983

---

GA-20-30-30

Office of Public Affairs  
Aviation Education Programs  
Washington, D.C. 20591

# ACKNOWLEDGMENT

---

---

For the compilation of the material in this book and the research required, the Civil Air Patrol is indebted to the earnest, fair minded teachers who were a part of the Curriculum Laboratory at the National Aviation Education Workshop held at Miami University, Oxford, Ohio. From their own experience they knew the needs of the classrooms and willingly and happily gave of their experience as well as of their time from school vacations. No one regional need is recognized above another, for on this small committee alone are represented the States of Hawaii, Indiana, Ohio, and New York, and the Commonwealth of Puerto Rico.

The ideas for illustrating the demonstration aids are theirs also, but certain of the drawings as they appear in the manual are the work of A/2C James E. Tapp, Headquarters Civil Air Patrol, and to him also is offered here our appreciation. Appreciation is also due Juanita Hilton for editing and combining into one book the several basic manuscripts prepared by the committee.

## Introduction: FROM TEACHER TO TEACHER

---

---

This manual is meant to be a springboard toward your own ideas for demonstrating concepts of the Air Age to your children, whatever the grade level. Even little children can learn scientific principles through simple teaching aids; older pupils can benefit by a review using the same demonstrations. In some instances, these aids may be set up by the teacher; in others, by the children as a group project; in still others, by each child with a minimum of teacher direction.

Many of these suggestions we have used in our own classrooms. All of them we feel to be of value in illustrating the principles involved. They are not new. Similar demonstrations and experiments may be found scattered throughout numerous books, but we have tried to assemble in one manual those we believe to be most helpful to the teacher in introducing her pupils to natural science. We do not pretend to cover the field, but trust in the ingenuity of our fellow-teachers to enlarge upon our beginnings.

Learn as you teach, and have fun!

The Committee:

Mary Coleman

Ramon Gonzales

Elizabeth Harris

Robert K. Iwamura

Wathen D. Leasor

# CONTENTS

---

---

	Page
Prologue: WHAT IS AN AIRPLANE?	
I. PROPERTIES OF AIR	
Air Takes Up Room .....	1
Air Has Weight.....	3
Air Has Pressure.....	3
Air Moves .....	5
Heat Causes Air to Expand.....	6
Air Contains Moisture .....	7
Warm Air Holds More Moisture Than Cold Air.....	7
Air Holds Some Things Up.....	8
Some Things Fly in the Air.....	9
II. WHAT MAKES AN AIRPLANE FLY?	
Wings.....	11
Propellers .....	13
The Jet Airplane .....	14
How Is a Plane Controlled? .....	14
The Wind Tunnel.....	16
III. WEATHER IS IMPORTANT TO AVIATION	
General Weather Conditions.....	19
Wind .....	20
Temperature .....	24
Moisture in the Air .....	28
Atmospheric Pressure.....	31

**An airplane is something like a bird—**

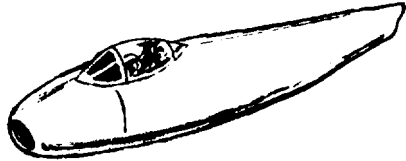
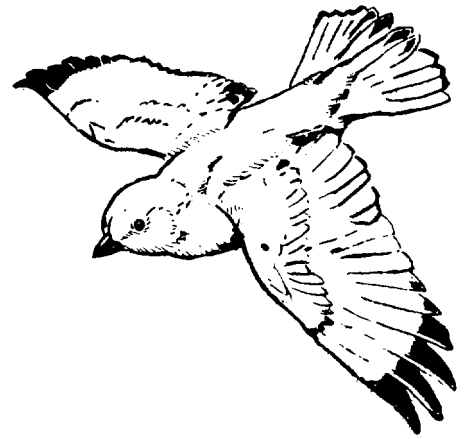

**It has a body;**

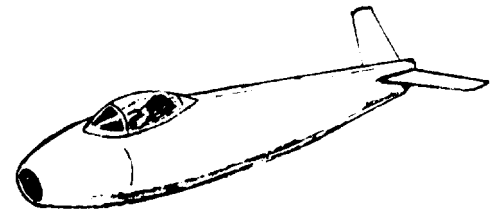

**and a flat tail;**

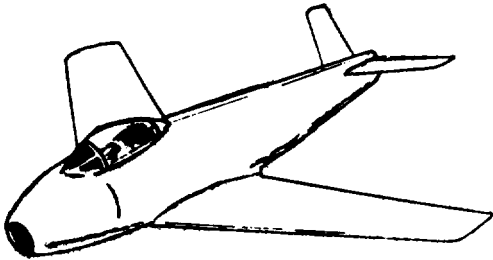

**and wings;**

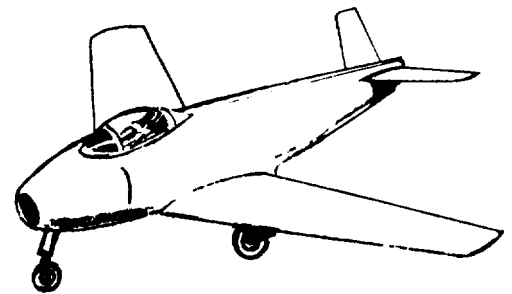

**and feet.**

# Prologue: WHAT IS AN AIRPLANE?

---

It is also something like a fish—

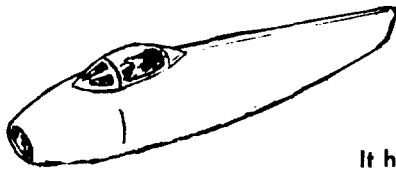
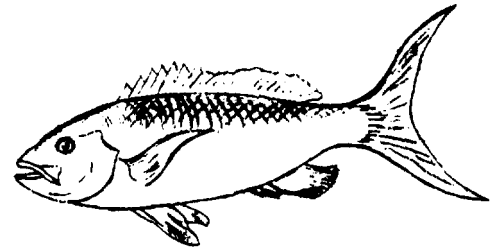

It has a body;

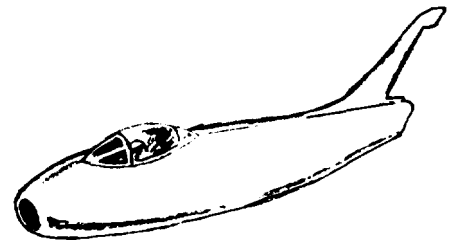

and a dorsal fin;

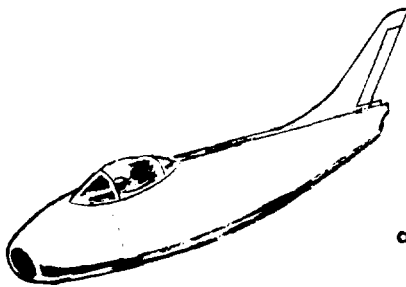

and a tail called a rudder;

So when we put the bird parts and the fish parts together we have an airplane.

Then we give it an engine to make it go and a pilot to steer it.

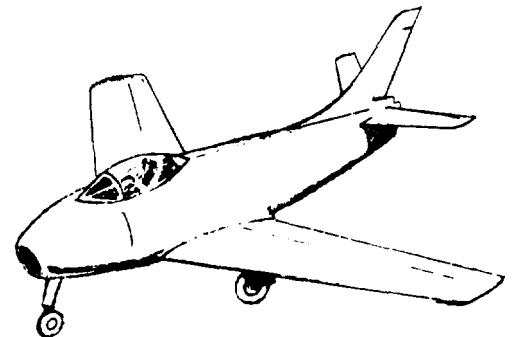

# I PROPERTIES OF AIR

*"What is it that you can touch  
But cannot feel;  
That has no size or shape  
But still is real?"*

## AIR TAKES UP ROOM

### 1. Equipment:

Soda pop bottle  
Small funnel  
Soda straw  
Modeling clay  
Cupful of water

Seal the funnel tightly into the neck of the bottle with modeling clay. Pour the cup of water into the funnel *quickly*. The water stays in the funnel because the air in the bottle cannot get out.

Pass the straw through the funnel into the bottle. Suck out a mouthful of air. Some of the water goes down into the bottle, taking the place of the air sucked out.

### 2. Equipment:

Wide-necked bottle or jar with an air-tight lid  
Soda straw  
Modeling clay  
Small balloon  
Thread

Blow the balloon up just enough to fit very loosely in the bottle. Tie a thread around the neck of the balloon so the air will not escape. Drop the balloon into the bottle. Punch a hole in the lid and insert the straw; seal it with modeling clay. Screw the lid on the bottle. Suck some of the air out of the bottle through the straw and clamp your finger over the top of the straw to prevent air from rushing back into the bottle. The balloon gets larger because the air inside the balloon expands as the air pressure decreases in the bottle.

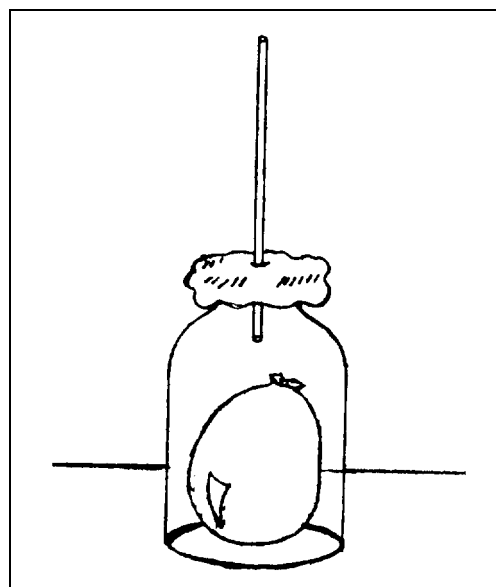
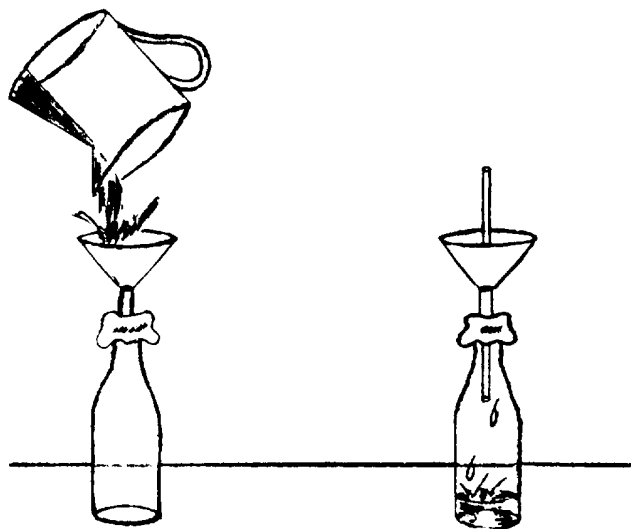

3. Equipment:

- Water glass
- Cork
- Large glass bowl
- Facial tissue

Fill the bowl about three-fourths full of water. Drop the cork on top of the water. Invert the glass over the cork and push to the bottom of the bowl. The cork goes to the bottom of the bowl under the glass. Air in the glass keeps the water out.

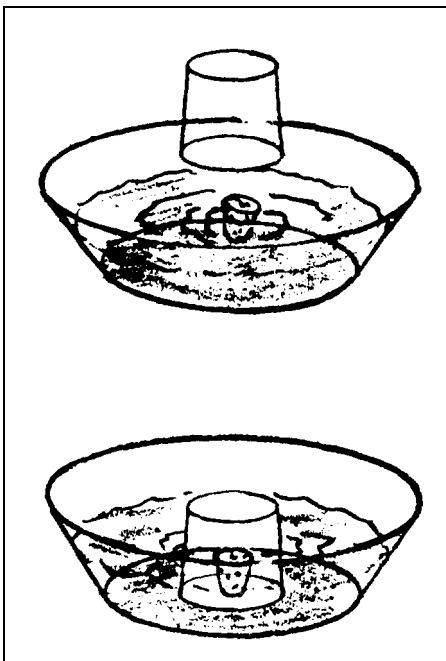

Remove the glass and the cork. Stuff facial tissue into the bottom of the glass. Invert the glass and push to the bottom of the bowl. The tissue doesn't get wet.

4. Equipment:

- 2 water glasses
- Large dish pan or other container filled with water

Air, like water, is fluid-you can pour it. Place one glass into the container so that it fills with water. Place a second glass into the water upside down so that the air does not escape. Carefully tilt the air-filled glass *under* the water-filled glass. By doing this, you can pour the air up in bubbles. Each bubble is a little package of air made visible by being in the water. With a little practice you can keep pouring the air back and forth between the glasses without losing any of it.

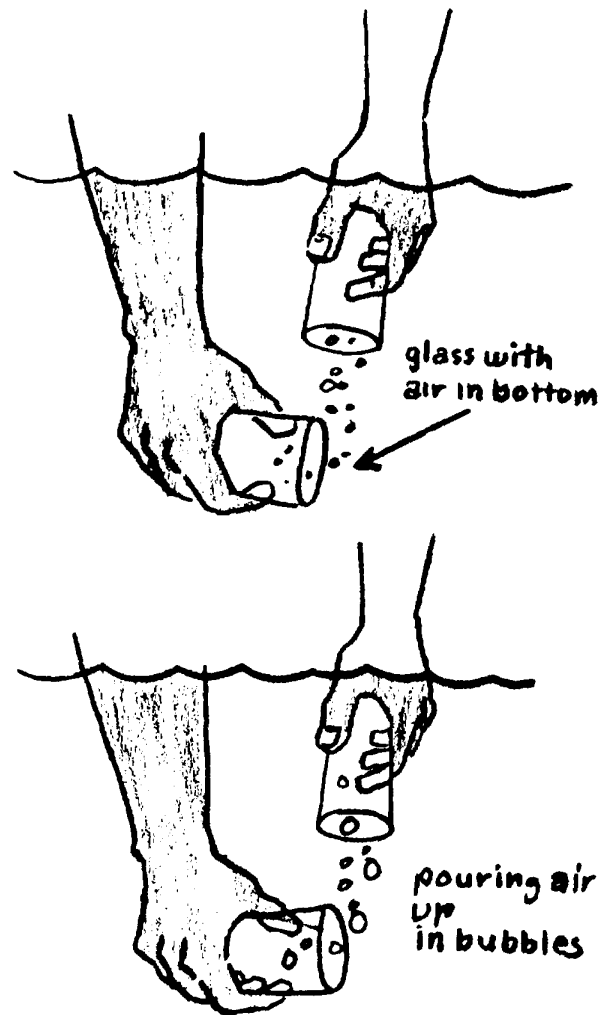

5. Equipment:

- Soda pop bottle
- Pan of water

Put the bottle into the pan so that it fills up with water. Before the water can get into the bottle, air must flow out. Watch the air bubbles as they rise to the surface of the water.

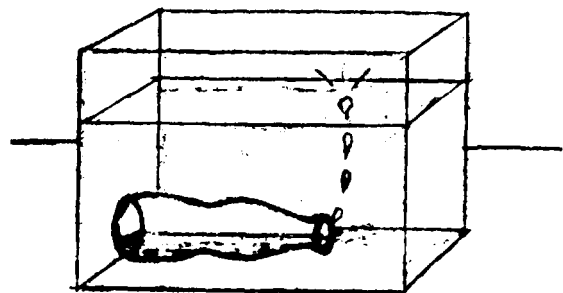

6. Equipment:

- Round balloon
- Long balloon
- Basketball
- Football
- Inner tube
- Paper bag
- Plastic bag
- Soap and water
- Bubble pipe

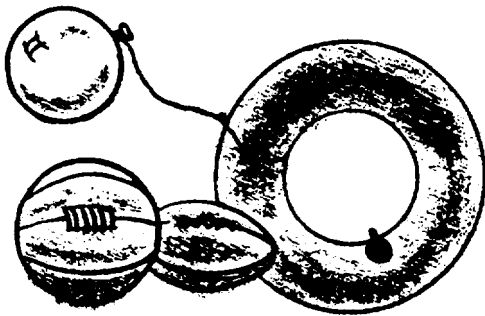

Blow air into a round balloon and into a long balloon. Put air into a basketball, a football, and an inner tube. Blow air into a paper bag. Catch some air in a plastic bag. Blow soap bubbles.

Air takes up room and assumes the shape of the object into which it is blown or into which it flows.

### AIR HAS WEIGHT

7. Equipment:

- Wooden dowel stock or tinker toy stick about a foot long
- String, 1 yard
- 2 balloons exactly alike

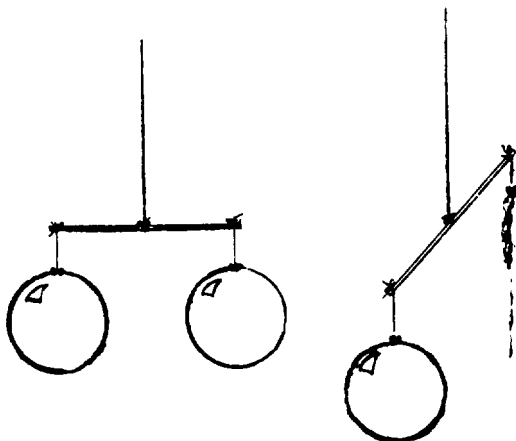

Blow up the balloons to the same size, and tie them at their necks with a piece of string. Tie one balloon to each end of the dowel stock. Attach another piece of string to the center of the dowel stock and suspend it from some convenient place. Balance the dowel stock. Prick one balloon with a pin. As the air rushes out, the pricked balloon shoots up and the heavier, air-filled one drops down.

8. Equipment:

- Football or basketball
- Good scale

Squeeze all the air possible out of the ball; then weigh the ball. Blow the ball up again and weigh it. The inflated ball should weight a few ounces more.

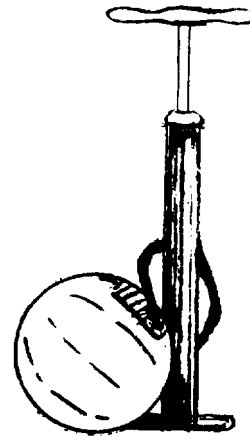

9. Equipment:

- Wooden upright
- Rod about 4 feet long
- Pail Sand or gravel
- Deflated ball (basketball, volleyball, or soccerball)
- Bicycle pump

Nail the rod at the center to the upright. Suspend deflated ball at one end and the pail at the other. Using the sand, balance the two. Inflate the ball, pumping as much air as the ball will take. Replace it.

The ball pulls down and unbalances the pail of sand, showing that air does have weight.

### AIR HAS PRESSURE

Since moving air particles have weight, they press with force against whatever they touch. Air presses upward, downward, sideways-every way. Air presses on

all sides of our bodies, but we do not notice it because our bodies are made to withstand this pressure.

**10. Equipment:**

- Water glass
- Piece of thin, fiat cardboard

Fill glass to the top with water. Place the cardboard over the glass. Carefully turn the glass upside down, holding cardboard tightly to the glass. Take your hand away from the cardboard. The cardboard stays in place against the glass. Tilt the glass or hold it sideways, and the cardboard still remains in place.

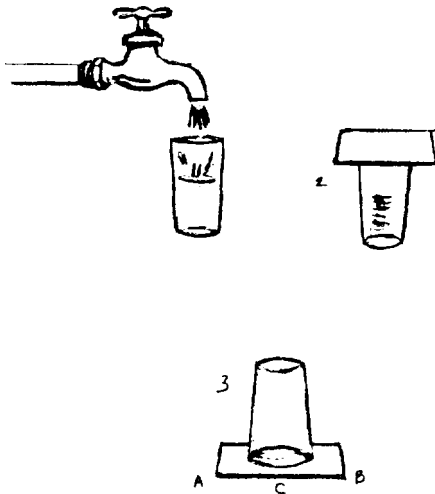

At A and B the upward and downward pressures balance, but at C the upward pressure of air is greater than the downward pressure of water and holds the cardboard in place.

**11. Equipment:**

- Soda straw or glass tube

Put your finger over the top of a soda straw filled with water. Lift or tilt it. The water will not run out because your finger cuts off the air pressure on top, but air still presses up against the water at the bottom of the straw. Take your finger away, and the water runs out of the straw.

**12. Equipment:**

- Bottle or jar with a tight cap
- Soda straw
- Modeling clay

Fill the jar up to the cap with water. Punch a hole in the cap and insert the soda straw. Seal tightly around the

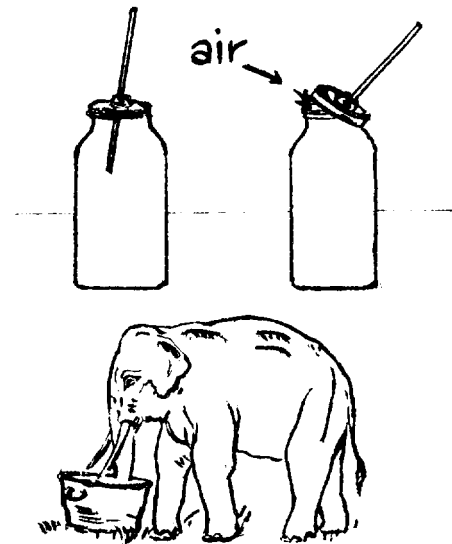

straw with clay. Put the cap on tightly so that no air can get into the bottle. Now try to suck the water out of the bottle. No matter how hard you suck, the water will not flow through the straw. Release the cap on the bottle just enough to let in some air, and try to suck the water through the straw. Now, as you suck through the straw, the air pressure is lowered inside the straw. Air pressing on the surface of the water in the bottle pushes it up through the straw as you suck through it.

An elephant has a built-in straw, and he puts air pressure to work every time he takes a drink. He puts his trunk in water and breathes in to draw the air out of his trunk. As he does this the water fills his trunk.

**13. Equipment:**

- Large medicine dropper or any kind of a tube with a suction bulb

Put the dropper or tube in a pan of water and squeeze the attached bulb, forcing the air out of the tube. Release the bulb. Water now rushes into the tube. Lift the tube out of the water. The water does not run out. Air pushes on the water in the tube and holds it there.

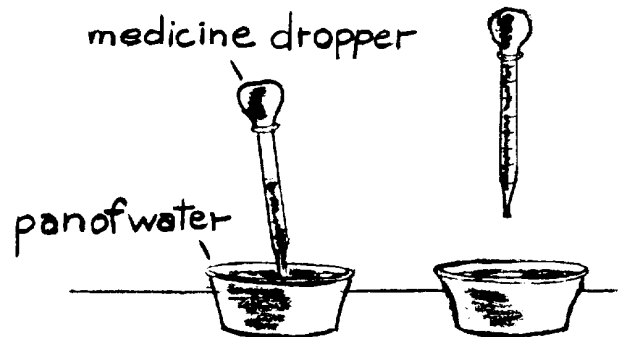

**14. Equipment:**

2 large, flat, rubber sink-stoppers

Air pressure tug-of-war: After wetting their surfaces, press the two sink-stoppers together so that no air is between them. Ask a friend to pull on one while you pull the other. You can't pull them apart. But just let the air get in between the pads or plungers, and presto! they separate.

**15. Equipment:**

Tin can with a screw-on metal cap, such as a maple syrup can  
Hotplate or burner

*Make sure the can is clean.* Pour about an inch of hot water into the can. Put it on the burner and heat it until you see the steam coming out of the opening. Wait another few seconds and *turn off the heat.* Screw the cap on tightly and wait for it to cool. The can suddenly begins to cave in.

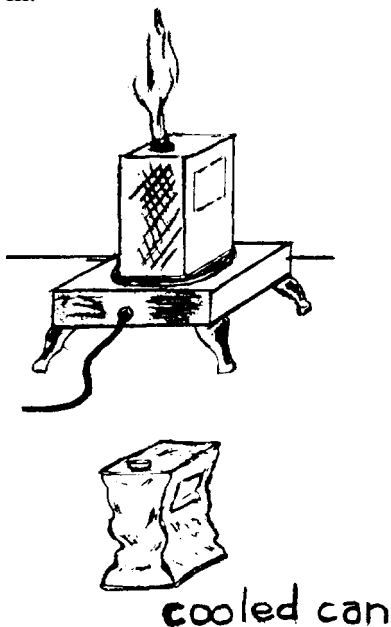

When it was heated water turned into steam, driving out most of the air. Now as the can cools, the steam turns back into water, leaving neither air nor steam inside the can. A partial vacuum has been created. Consequently, the pressure of air outside the can, being greater than that inside the can, crushes the can.

**AIR MOVES**

The air is moving all the time, whether we feel it or not.

**16.** Put some rather strong perfume on a piece of cotton. Have the children raise their hands as soon as they smell it.



**17.** Burn a piece of string or a piece of "punk" in a dish. Notice the direction the smoke travels.



**18.** Notice the trees. Are the leaves moving? Are the trees bending?



**19.** Wind is moving air. Create a wind by fanning yourself with a piece of paper, moving your arms rapidly back and forth and turning rapidly around the room.



20. Hold a sheet of paper at mouth level and blow hard.

21. Hold a sheet of paper in front of an electric fan. Fasten some strips of paper to the electric fan.

22. Blow a ping-pong ball across a table top.

23. Equipment:

- Card
- Cork
- Fan
- Thumb tack
- Soda straw
- Pan of water

Make a toy sailboat out of a card, cork, and a thumb tack. Put it in the sink or in a pan of water. Blow on it. Blow on it through a straw. Fan it with a fan.

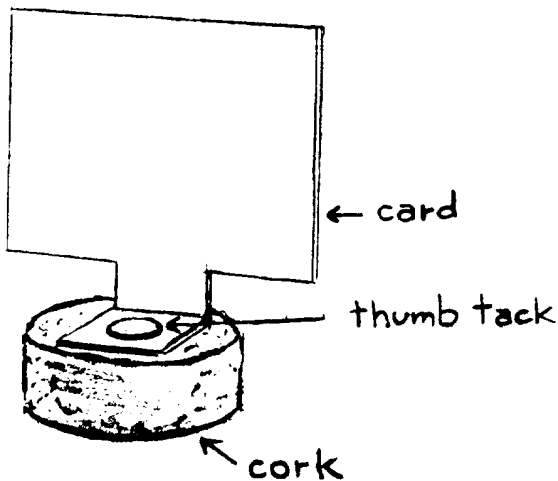

24. Equipment:

- Paper, 6 inches square
- Pin
- Pencil with eraser

Make a simple pinwheel. Draw diagonal lines across the 6-inch square of paper. Cut along the lines to a point about one-half inch from the center of the square. Bring alternate points together so that they overlap in the center. Push a pin through the points of the paper and the center of the square and then into the eraser on the end of a pencil (A stick rather than a pencil may be used.)

Blow on it; walk with it; run with it, holding it at different angles as you run. Hold it near the blower of a ventilating system or in front of an electric fan.

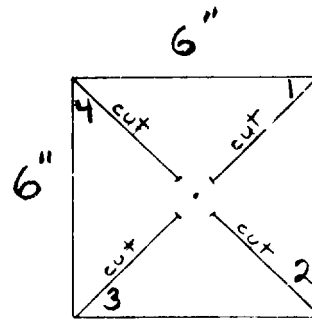

pin to center corners 1,2,3,4

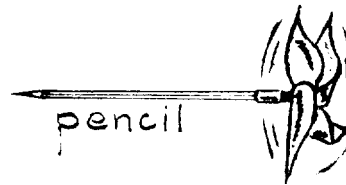

**HEAT CAUSES AIR TO EXPAND**

25. Equipment:

- Balloon
- Thread
- Iced water or snow

Blow up a balloon. Tie the end tightly to prevent air from escaping. Hold the balloon over a hot radiator or other source of heat. Heat will cause the air in the balloon to expand. Put the balloon on snow or in a dish of iced water. Cold will cause the air in the balloon to contract.

26. Equipment:

- Balloon
- Bottle or water glass
- Candle or pan of hot water

Put a balloon over the mouth of an empty bottle or glass. Heat the air in the bottle over a lighted candle, a pan of hot water, or a hot radiator. The heated air expands and further inflates the balloon.

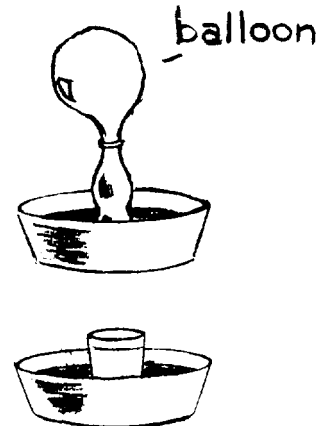

27. Equipment:

- Balloon
- Water glass
- Pan of hot water
- Scissors

Cut the neck of a balloon. Heat an empty glass in a pan of hot water. Slip the opening of the balloon over the mouth of the glass. Let the glass cool. The cool air contracts and sucks the balloon into the glass.

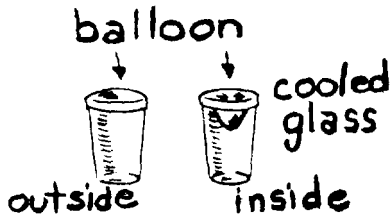

28. Equipment:

- Bubble pipe
- Soapy water

Blow soap bubbles. Discuss why they float. (The breath is warm; as the bubbles begin to cool they begin to settle. Observe what happens when you blow bubbles over a hot radiator.)

29. Equipment:

- Test tube
- Cork

Put a cork in a test tube, but not too tightly. Hold the corked tube over a source of heat. As the air warms and expands, the cork will pop out.

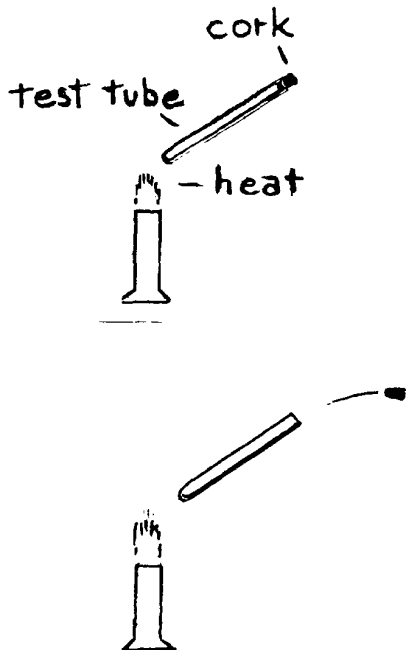

30. Equipment:

- Ordinary thermometer

Find the temperature of the air near the ceiling and near the floor. Compare the readings and discuss why the warmest air is near the ceiling.

31. Equipment:

- Strips of paper
- Thumb tacks or scotch tape

Open a window at the top and at the bottom. Fasten strips of paper so that they will hang in the openings and be moved by the air currents. Notice where the air is moving into the room and where it is moving out. The air coming in at the bottom of the window is cooler than the air in the room. It forces the warm air to rise.

**AIR CONTAINS MOISTURE**

32. When the children paint pictures, discuss where the water goes when the pictures dry.

33. Discuss what happens to the water given to potted plants.

34. Put some water in a shallow dish on the window sill. Leave it for a few days, then observe. Where did the water go?

35. Boil a small amount of water in a shallow pan. Observe what happens. Discuss what happens when water evaporates. Help the children to understand that water evaporates from rivers, lakes, streams, and ponds and that when water evaporates it goes into the air as water vapor.

**WARM AIR HOLDS MORE MOISTURE THAN COLD AIR**

36. Equipment:

- 2 water glasses
- Ice cubes

Fill one glass with warm water. Fill another glass with water and ice cubes. Water collects on the outside



of the glass which has the ice cubes in it. This is because the cold glass comes in contact with the warm, moist air of the room. Help the children understand why this happens. (This experiment works better on warm, moist days in the spring, summer, and fall than in artificially heated rooms in the winter.)

**37. Equipment:**

- Teakettle with a spout
- Hot plate or burner
- Large strainer
- 2 trays of ice cubes
- Medium-sized pan with handle

Boil water in the teakettle until steam comes from the spout. Notice that the steam disappears into the air almost immediately. Fill the strainer full of ice cubes and hold it near the spout of the teakettle so the steam will go through it. Clouds form as the steam cools. Help the children understand why.



Fill the pan with ice cubes and hold it where the steam from the teakettle will hit the sides of the pan. When the hot vapor or steam hits the sides of the pan, little drops of water gather on the outside of the pan and drip like rain.

**AIR HOLDS SOME THINGS UP**

The force of gravity acts constantly upon objects, causing them to fall toward the earth. Objects rise only when the force of the air upward is greater than the force of gravity downward.

Leaves float in the air.

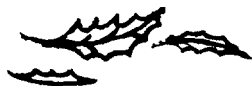

Some seeds are carried by the wind.

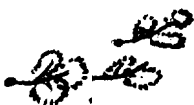

A balloon filled with a gas lighter than air rises and floats in the air.



A blimp is a kind of balloon filled with a gas which is lighter than air.

**38. Equipment:**

- Silk handkerchief
- Small ball or doll
- String

Make a parachute with a silk handkerchief, some string, and a small ball or a small doll. Tie about ten inches of string to each corner of the handkerchief. Fasten each piece of string to the ball or the doll. Toss the parachute into the air, or let the children drop it from the top of the "monkey bars."

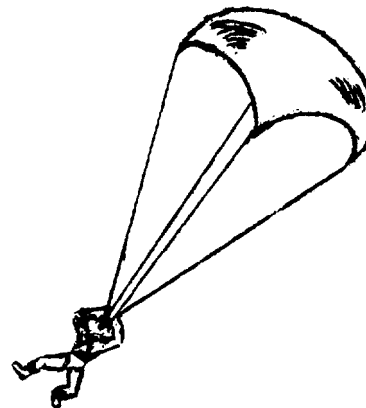

A parachute floats' downward toward the earth through the air. When an object falls from a great height it picks up speed, but the resistance of air finally causes it to fall at a steady speed called *terminal velocity*. The large surface of a parachute acts as an air brake, checking the velocity of the person or object attached and making possible a safe landing.

**39.** Have the children repeat this experiment with other objects—a feather, a piece of paper, a pencil, a silk scarf, a piece of cotton cloth, a kite, etc. Take the objects outside on a windy day and try them out.

**40. Equipment:**

- 1 stick, 1/4" x 8" x 24"
- 1 stick, 1/4" x 8" x 24"
- Paper, strong, 16" x 24"
- Glue
- Long, narrow strip of cloth
- String

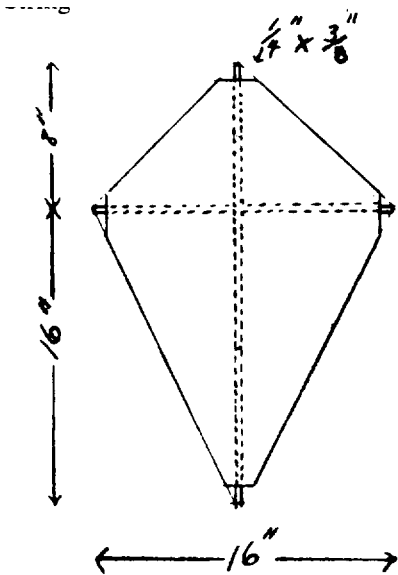

The forces acting on a kite:

Wind pressure beneath the kite tends to hold it up.

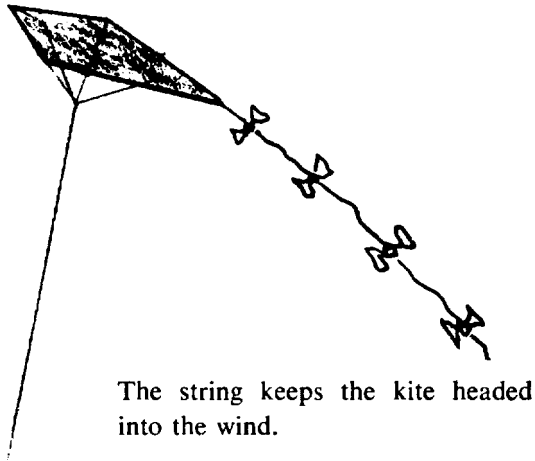

The string keeps the kite headed into the wind.

The tail keeps the kite upright.  
Gravity tends to pull the kite down.

Wind helps a kite fly, unless the kite is being pulled through the air. A kite should be held at an angle to the wind which allows the air to strike against the under surface of the kite in such a manner as to direct the kite upward as the air striking the kite is deflected downward.

If you release the kite string, the kite will fall to the earth. It falls because the angle at which the surface of the kite has been held toward the wind has been changed. The lift upward caused by the angle at which the kite attacked the air is now less than the pull of gravity downward.

**SOME THINGS FLY IN THE AIR**

A bat is a mammal that flies in the air.



A bird is a fowl that flies in the air.

A butterfly is an insect that flies in the air.

An airplane is a machine that flies in the air.

**41. Equipment:**

- Toy airplane with rubber band motor
- Balsa glider

Compare a toy airplane having a rubber band motor with a balsa glider. Let the children fly them. The toy airplane has wings like a big airplane. It has a propeller and a motor. The rubber band is the motor. You turn the propeller to wind up the rubber band. When you let go the rubber band unwinds and turns the propeller. The propeller pulls the toy airplane through the air.

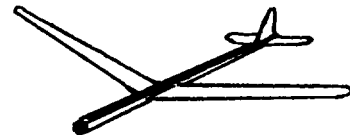
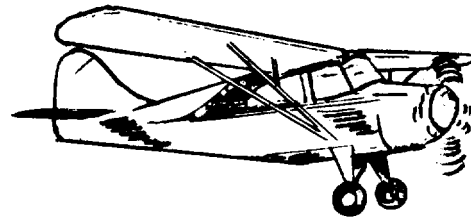

The glider does not have a propeller or a motor. When you toss the glider into the air, the air pushes up on the wings. This pressure keeps the glider from coming straight down.

## II WHAT MAKES AN AIRPLANE FLY?

### WINGS

The force that lifts an airplane and holds it up comes in part from the air that flows swiftly over and under its wings.

#### 42. Equipment:

Strip of notebook paper or newspaper, about 2 inches wide and 10 inches long

Book  
Paper clips

Make an *airfoil* (wing) by placing one end of the strip of paper between the pages of the book so that the other end hangs over the top of the book as shown in diagram A. Move the book swiftly through the air, or blow across the top of the strip of paper. It flutters upward.

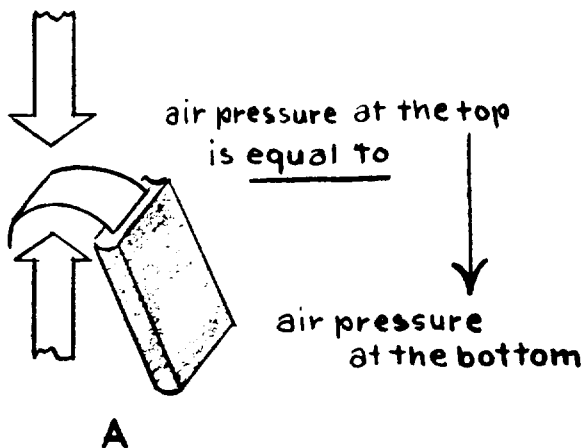

Hold the book in the breeze of an electric fan so the air blows over the top of the paper

Take the strip of paper out of the book. Grasp one end of the paper and set it against your chin, just below your mouth. Hold it in place with your thumb and blow over the top of the strip. The paper rises. Try the same thing after you have fastened a paper clip on the end of the strip. See how many paper clips you can lift in this way.

Hold the strip of paper in your hands and run around the room.

It doesn't matter whether you move the air over the strip of paper by blowing or whether you move the paper rapidly through the air—either way it rises.

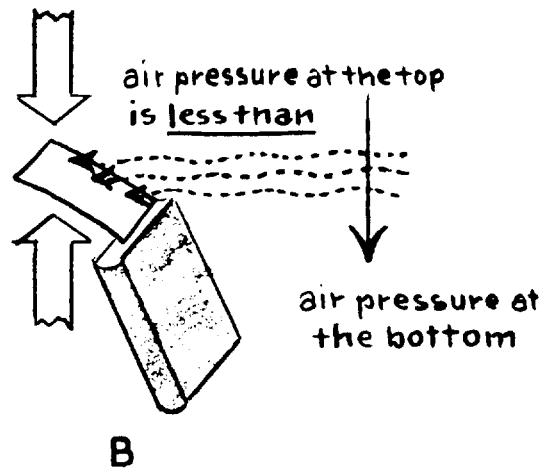

*Bernoulli's principle* states that an increase in the velocity of any fluid is always accompanied by a decrease in pressure. Air is a fluid. If you can cause the air to move rapidly on one side of a surface, the pressure on that side of the surface is less than that on its other side.

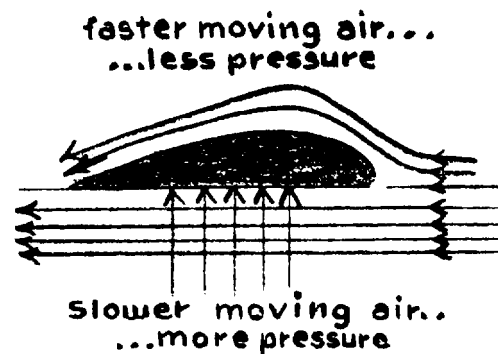

Bernoulli's principle works with an airplane wing. In motion, air hits the leading edge (front edge) of the wing. Some of the air moves under the wing, and some of it goes over the top. The air moving over the top of the curved wing must travel farther to reach the back of the wing; consequently it must travel faster than the air moving under the wing, to reach the trailing edge (back edge) at the same time. Therefore the air pressure on top of the wing is less than that on the bottom of the wing.

**43. Equipment:**

2 sheets of notebook paper

Hold two sheets of notebook paper about four inches apart. Blow between them. Instead of flying apart they come together. The air moving rapidly between

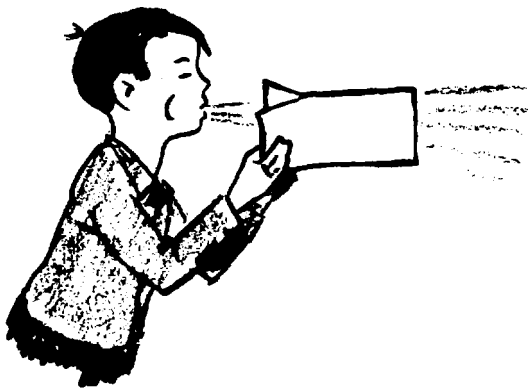

the two pieces of paper has less pressure than the air pressing on the outer sides of the paper.

**44. Equipment:**

Pin  
Spool  
Cardboard, 3" x 3", lightweight but firm

Place the pin through the center of the cardboard. Place the spool over the pin so that the pin goes into the hole in the spool. Hold the card against the spool and blow firmly through the spool. Release your hand. The card does not fall.

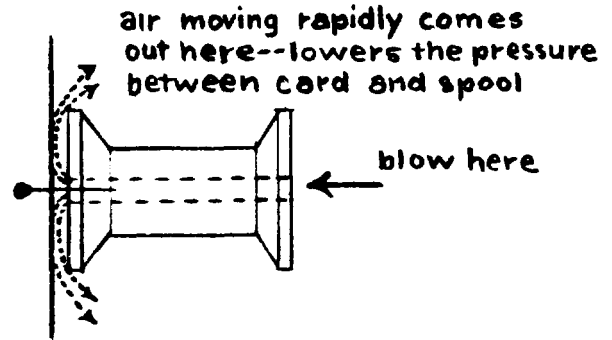
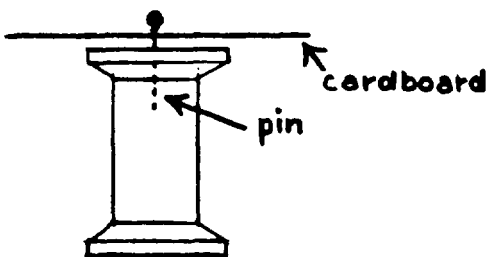

**45. Equipment:**

Ping-pong ball  
Tank-type vacuum cleaner

Connect the hose to the blower rather than to the suction end of the vacuum cleaner. Turn the switch on. Hold the hose vertically so the stream of air goes straight

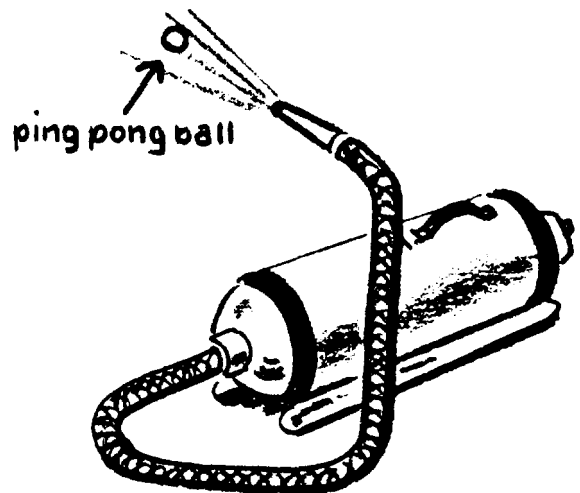

up. Release the ping-pong ball into the stream of air about a foot from the nozzle. Slowly tip the nose so that the air shoots at an angle. The ball will stay suspended in the airstream. The force of gravity upon the ball tends to make it drop out of the airstream. However, the fast moving airstream lessens the air pressure on the portion of the ball remaining in the airstream, overcoming the force of gravity, with the result that the ball remains suspended.

## PROPELLERS

Wings give an airplane lift, but they do not drive it forward. In some airplanes the propeller (turned by an engine) drives the plane forward by pushing the air backward. The air, reacting to the action of the propeller, pushes it forward. (For every action, there is an equal and opposite reaction—*Newton's Third Law of Motion.*) As the propeller is attached to the plane, it pulls the plane through the air.

### 46. Equipment:

Wagon or roller skate  
Small electric fan with long extension cord

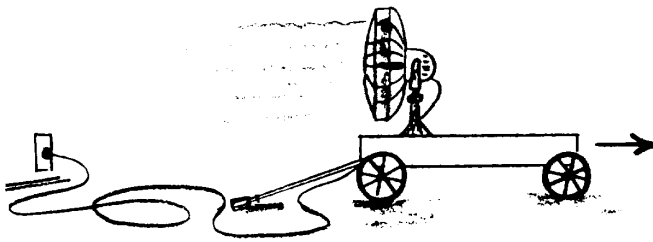

Put a propeller on anything that can move—a wagon or a roller skate. Use a small electric fan with a very long extension cord for a propeller. Set it firmly on the roller skate or wagon. The fan drives the wagon or skate backwards. This is because the blades are set to throw the air in front of the fan.

### 47. Equipment for making a cardboard propeller:

Cardboard, 3 1/2" x 1 1/4"  
Soda straw

Cut along the dotted lines as shown in diagram.

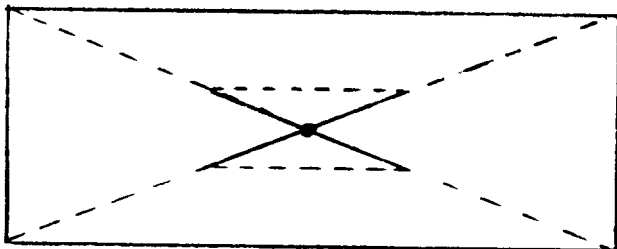

Carefully and slowly push a pencil point through the center, turning the pencil as you do so. Make the hole just barely big enough to push the soda straw through. Bend the blades at an angle. Spin the straw between your fingers. Notice where you feel the breeze.

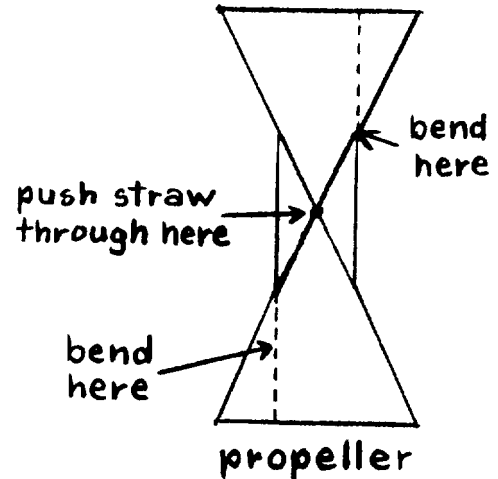

### 48. Equipment for making a balsa wood propeller:

Spool  
Knife  
Strong twine  
Small finish nails  
Tenpenny nail  
Block of balsa or other soft wood  
Block of wood, 2" x 2" x 3"  
Hacksaw  
Nail cutter or large pliers

Drive the tenpenny nail into one end of the wooden block. Cut off the head of the nail so that the nail is shorter than the length of the spool. Drive the finish nails into one end of the spool. Space them evenly between the hole and the edge of the spool. Carve a propeller from the balsa wood. Drill two holes in it to match the finish nails on the spool. Wind the string on the spool and place the propeller on it, making sure to match the holes to the finish nails. Pull the string hard and fast.



string

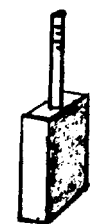

headless  
nail

woodblock

The spool and propeller are spun with great speed and the revolving propeller will fly off, high into the air.

49. A simpler demonstration can be done by twisting a pencil or chopstick tightly into the hub of the propeller. Hold the stick between the palms of both hands, propeller up. Roll it back and forth quickly three or four times and push it forth into the air. The prop, stick and all, will fly off into the air and attain good height, demonstrating that a revolving prop creates thrust.

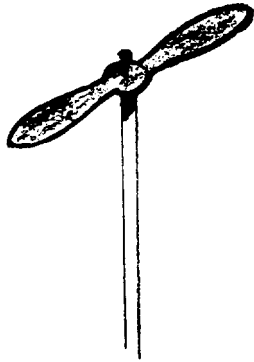

### THE JET AIRPLANE

A jet aircraft has no propeller. Instead it has a reaction engine in which fuel is burned to expand the air and build up great pressures. It also has a tailpipe through which the expanded air and other gases can escape. The plane is moved forward by the pressure of the gases inside its engine. Its rate of speed were it in a vacuum would be the same as that of the escaping gases.

50. You can see how a jet works by an experiment which uses a toy balloon. Blow up the balloon; pinch the neck to keep in the air. Let the balloon go. It shoots across the room. The air inside the balloon is pushing in all directions to get out. Some of the air escapes through the open neck, but the air at the opposite end of the balloon cannot get out, so it pushes the balloon forward.

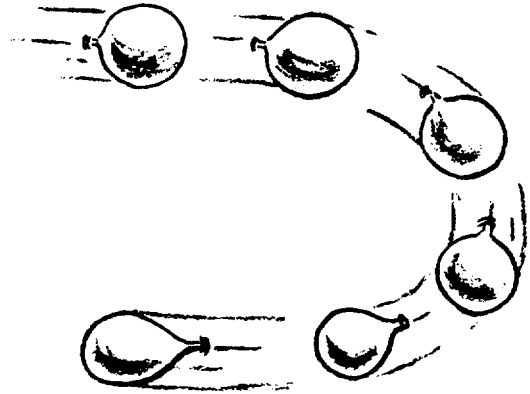

### HOW IS A PLANE CONTROLLED?

A car can go only right or left, but a plane must be steered up or down as well. It has parts on the wings and tail called control surfaces to help it. These can be demonstrated by the use of folded paper gliders and balsa gliders.

51. Folded paper glider. Use a piece of paper 9" x 6".

The finished glider can be held together at the bottom with a paper clip. The paper clip can also be used for a balance. Experiment with the glider, moving the clip up or back as needed to obtain proper balance.

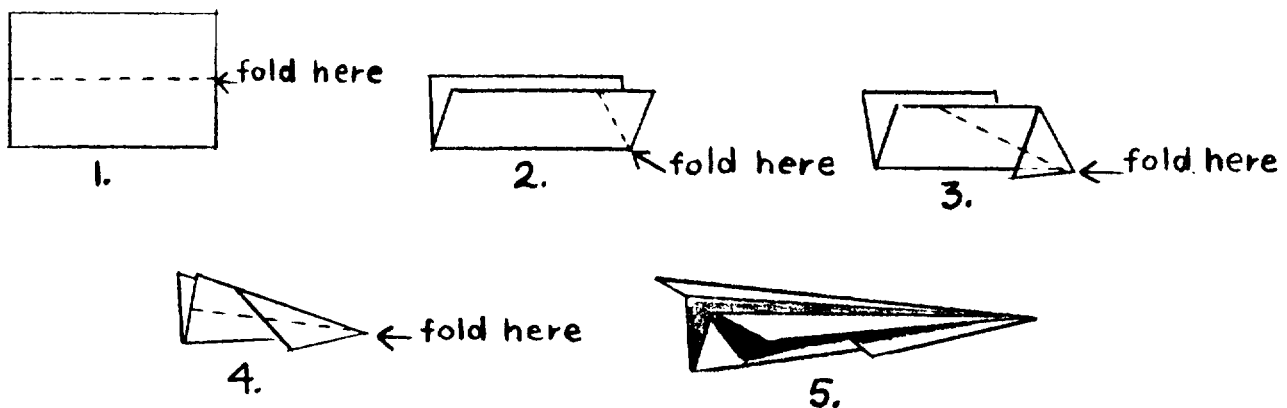

Experiment further by changing the position of the wings (see 52a. *Up and down*).

**52. Control surfaces.** Real planes have segments inserted in wings, in the vertical stabilizer, and in the horizontal stabilizer. These are called ailerons, rudder, and elevator. The pilot controls their position from the airplane cockpit. When he moves them into the air-stream, they cause the plane to react to air pressure. By using them he can go to the right or left and also up and down.

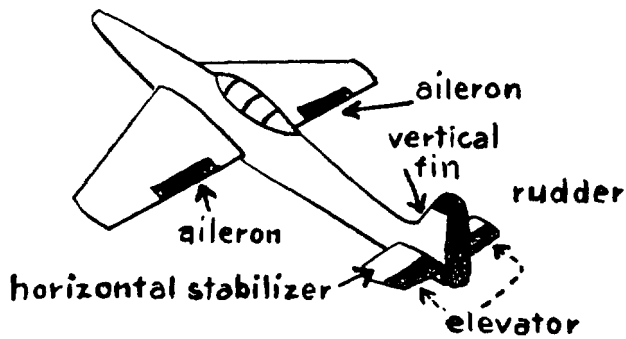

a. *Up and down.* Fold the back edges of the paper glider *up*, as in the diagram. When you throw the glider, the tail should go down and the nose should point up. It may take some practice to get the controls set so the glider does what you want it to do.

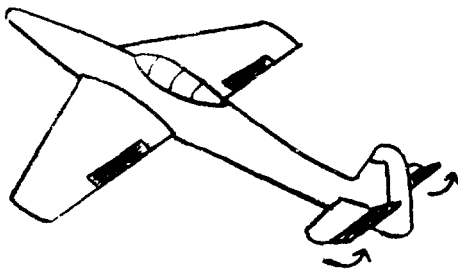

When the pilot wants his plane to climb, he moves his controls so that the elevators tilt up in the same way that you folded the back edges of the glider. The air hitting the elevators pushes the tail of the plane down, tilting the nose upward, so that the plane can climb.

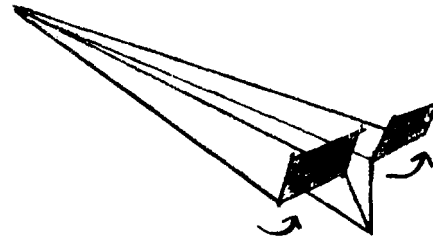

Fold the back edges of the glider *down*. When you throw the glider, the tail should go up and the nose should go down. This same thing happens when the pilot tilts the elevators downward.



b. *Right and left.* Turn the vertical fin on the glider a little to the right; the glider will fly toward the right. The pilot moves his rudder to the right for a right turn, but he must also bank his plane for the turn, the same as you would do if you were turning on a bicycle. (You would lean to the right for a right turn.) The pilot tilts his plane to one side by using the ailerons. When one tilts up the other tilts down.

To tilt the plane to the *right*, the pilot tilts the left aileron down so the left wing is pushed up. The right aileron is tilted up so the right wing will be pushed down. You can do the same thing with a paper glider. (This principle can be illustrated also by suspending the glider in a wind tunnel.)



For a *left turn*, the pilot reverses the process described above.

**To Suspend a Paper Glider in a Wind Tunnel:**

**53. Equipment:**

- Airplane rubber
- Notebook reinforcement rings
- Glue
- Pill

Purchase airplane rubber (by the yard) at a hobby shop. Slip one end of the rubber between two notebook reinforcement rings and glue them together.

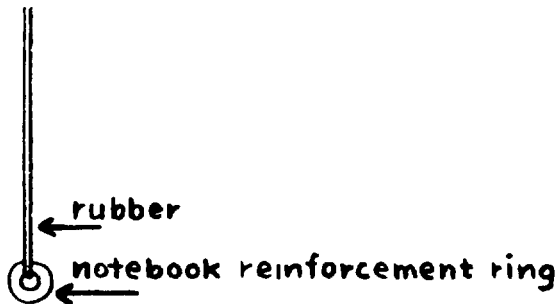

Fasten this end to the glider as shown in the diagram below; then anchor with a pin. Even kindergarten children can use this method of suspending a glider in a wind tunnel. (See No. 55.)

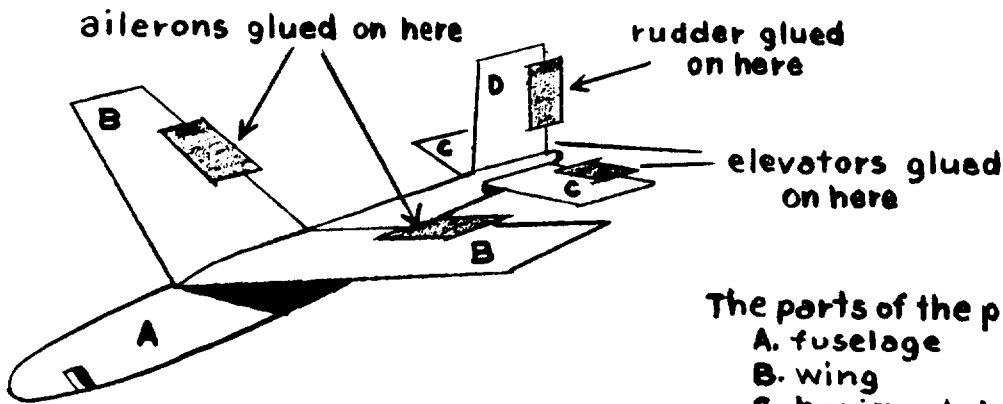
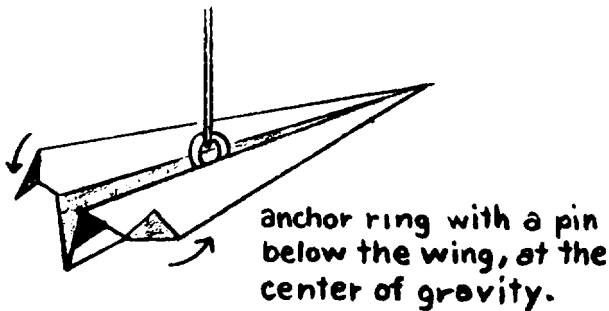

- The parts of the plane**
- A. fuselage
  - B. wing
  - C. horizontal stabilizer
  - D. fin, or vertical stabilizer

**54. Equipment:**

Balsa glider

A balsa glider may also be used to illustrate the function of control surfaces. Assemble the glider and launch it a few times for practice. Make ailerons, elevators, and a rudder from rather lightweight paper; glue them to wings and stabilizers. Now, see what you can do with the glider. With practice you will become skilled enough to make the glider fly where you want it to fly.

This kind of glider is excellent to use in a wind tunnel to illustrate the effects of control surfaces. Remember what the control surfaces help the plane do:

- Climb.....The elevators are up.
- Glide or dive..The elevators are down.
- Right turn.....Turn the rudder right.
- Right bank.....The right aileron is up; left aileron is down.
- Left turn.....Turn the rudder left.
- Left bank.....Turn the left aileron up; right aileron down.

**THE WIND TUNNEL**

A *wind tunnel* is a tunnel-like chamber through which air is forced at controlled velocities to study the airflow about the object suspended within it. Some wind tunnels are large enough to permit the action of wind pressure on huge airplanes or missiles to be observed, and in these the wind velocity may have a force of several thousand miles per hour. Other wind tunnels are small, with scale models of airplanes mounted in them.

The wind tunnel described below is a simple one for use with very young children. This type was used very effectively for six weeks with a kindergarten group. The children made their own paper gliders and tested them in the tunnel.

**55. Equipment:**

- Piece of furnace pipe about 4 feet long
- Piece of pliofilm, acetate, or some other transparent material for the tunnel window
- Separations from an egg carton
- Scotch tape
- Corrugated box, the same size as the egg carton separators
- Small electric fan
- Bookbinding tape or similar adhesive tape
- 2 small hooks, the kind used for hanging cups
- Metal shears

Open the egg carton separators and reinforce the corners with scotch tape. Open the corrugated box on both ends and push the flaps inside the box to make the box stronger. Fit the egg carton separators into one end of the box. They should fit snugly.

With a pair of metal shears, cut a window near one end of the furnace pipe. Cover the window with the transparent material, securing it to the pipe with book-binding tape. Fasten the hooks in the pipe so that when the glider is suspended from the top hook it can be observed from the window.

Set the egg carton separators flush against the furnace pipe, at the end opposite the window. Set the electric fan inside the box containing the egg carton separators. These separators honeycomb" or straighten the swirling air currents from the electric fan.

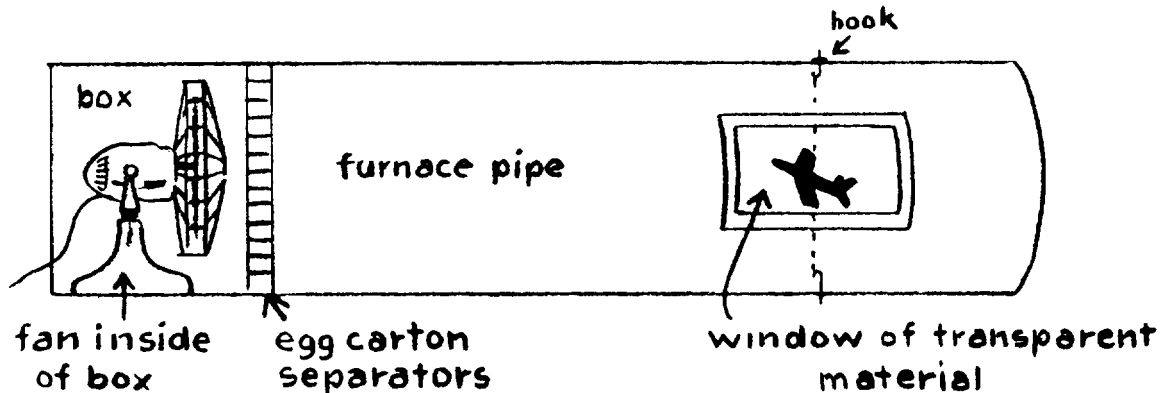
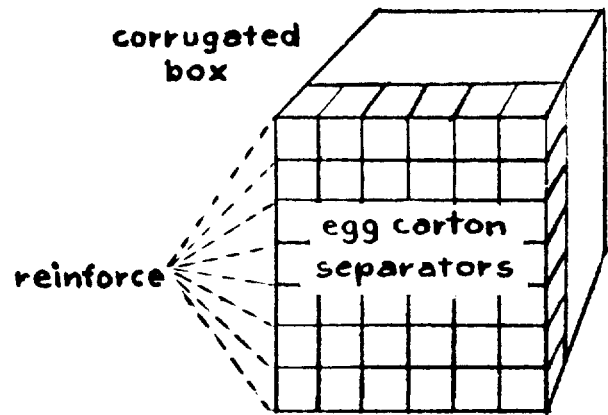

# III WEATHER IS IMPORTANT TO AVIATION

## GENERAL WEATHER CONDITIONS

There are many kinds of weather; weather may vary from day to day.

56. Keep a weather calendar or weather chart. Use a large, printed school calendar. Circle each day with color representing the type of weather, such as orange for sunny, blue for cloudy, black for rainy.

57. Chart the weather for a month, using weather symbols like the following:

Sunny

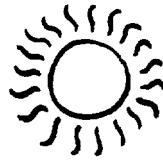

Cloudy



Rainy



Snowy



Weather changes may take place rapidly. Record variations in weather during the day. Try to choose a windy or very humid day. If a storm rises, note how quickly it may have risen.

Weather combinations vary. Note types of precipitation accompanying hot days; cold days. Note also daily cloud formations and their approximate heights above the earth.

Weather can often be predicted by observing sky conditions.

58. Note the degree of visibility. Is it affected by haze, fog, rain, or other forms of precipitation, or is it clear?

59. Note types of clouds:

cumulus: fluffy, cottony masses; may precede heavy rains and turbulent winds, forecasting colder temperatures.



stratus: horizontal layers; may be accompanied by haze, fog, drizzle, or rain, forecasting warmer temperatures.

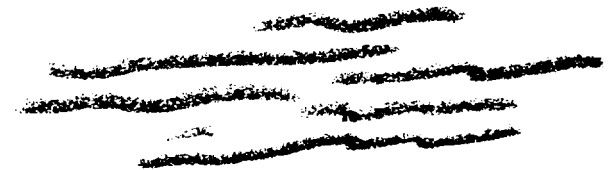

60. Note force of wind (see No. 65). High winds mean weather changes are coming.

61. Make a chemical *hygrometer* to show the moisture content of the *atmosphere*.

Equipment:

Gum arabic .....	½ ounce	Small doll with
Cobalt chloride.....	1 ounce	cotton skirt
Sodium chloride....	½ ounce	Cardboard
Calcium chloride...	75 grains	Cotton cloth
Distilled water.....	1 ounce	

Mix the chemicals into one solution. Dress a small doll with a skirt of cotton cloth treated with the solution just mixed. Cut out cardboard rabbits and place on them large cotton cloth ears treated with this formula. To treat, dip cloth into solution; let dry.

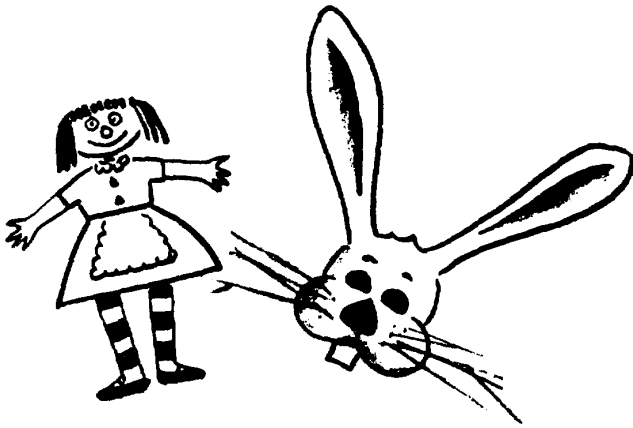

Cloth will be blue on dry, clear days; lavender on days when weather is changing; and pink when it is raining or the humidity is high.

**62.** Make clouds.

On a cold or foggy day, let out your breath so that you can see it.

Boil water in a teakettle. Hold a strainer containing ice cubes near the spout. See the clouds of steam.

Make a Wilson Cloud Chamber (see No. 97).

**63.** Measure *precipitation* (the observable moisture that comes out of the air).

Equipment:

- Tall glass jar, such as an olive jar, 2-inch diameter preferred
- Stopper with 1 hole, to fit jar
- Funnel to fit hole, 4-inch diameter at top preferred

Keep the jar outdoors to trap rainfall. Place it where surrounding objects will not interfere with rainfall. After each storm measure the height in the jar of the accumulated fall.

Insert funnel through stopper, and stopper into jar opening. If 4-inch funnel and 2-inch diameter jar are being used, mark jar height into 1-inch intervals. Then each inch of depth will be equivalent to 4 inch of rainfall. (Note: If jar and funnel are not of these dimensions, figure markings on jar in proportion.)

**64.** Keep a detailed weather record.

Make a chart like the one which follows and keep a record for a week. Make observations at the same time each day.

**WIND**

**Wind Has Force**

Many devices depend upon the force of the wind for their successful operation. Among these are pinwheels, windmills, gliders, balloons, sailboats, fans, and the like.

**65.** Make a pinwheel, using sheet of paper 9" x 9" (See No. 24)

Hold the pinwheel in a strong wind or out the window of a moving car, or make your "wind by running. Wind will catch the blades of the pinwheel and make it spin.

**Weather Record**

Date							
Precipitation							
Air Temperature							
Air pressure							
Relative humidity							
Wind direction							
Wind speed							
Sky condition							
Type of clouds							

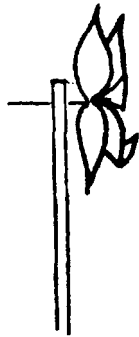
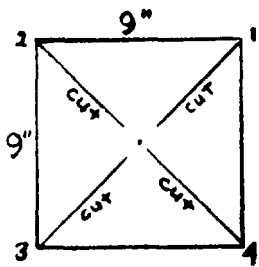

Experiment to see whether there is any angle toward the wind at which you might hold your pinwheel without it spinning. When does it slow down? Is it when the plane of the blades is parallel to the wind? Each blade is an airfoil. Can you explain why? (See No. 42.)

**66. Make a windmill**

Equipment:

- Pinwheel
- Small frozen-juice can (dean. empty)
- Paper, about 9" x 9"
- Scotch or masking tape

Wrap the paper around the can as shown in the illustration. Fasten it with tape. Insert the pinwheel shaft through the paper covering near the top. Place the completed windmill in an open window so the blades will catch the breeze.

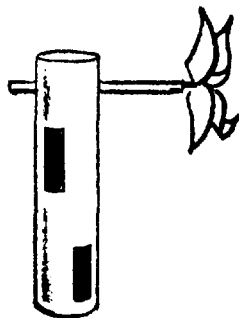

**67. Make a fan.**

Equipment:

- Construction paper, 11" x 8½"
- Stapler

Decorate both sides of a piece of construction paper, 11" x 8½". Starting at the short side, fold over and under, with strips 3A" wide, down length of paper.

Hold one end of the folded paper firmly and staple, using stapler several times and on both sides if necessary.

Holding stapled end, flip wrist rapidly so that the fan creates a "wind."

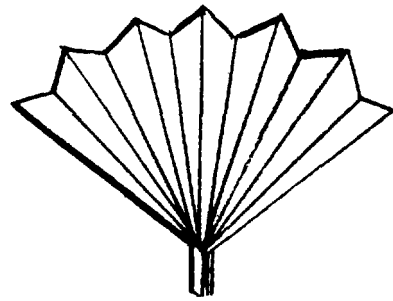

**Wind Has Convection Currents**

*Convection currents* are caused when heated air rises and cold air falls. (Explain why there is better ventilation in a room when the window is open both at the top and the bottom.)

**68. Equipment:**

- Stick of punk or cigarette paper
- Candle or other source of heat
- Ice or other source of cold

Light a stick of punk or, if that is not available, use a piece of cigarette paper rolled so that it will not burn too quickly. Hold the smoking punk near hot objects (stove, radiator, lighted candle, hot brick, lighted electric bulb, etc.) and watch the path of the smoke. Hold the punk near cold objects (open refrigerator door, cake of ice, cold windowpane, cold brick, etc.) and watch the path of the smoke.

**69. To show that heat rises:**

Equipment:

- Glass lamp chimney
- Candle
- Cover glass
- Wood splinter
- Small sticks

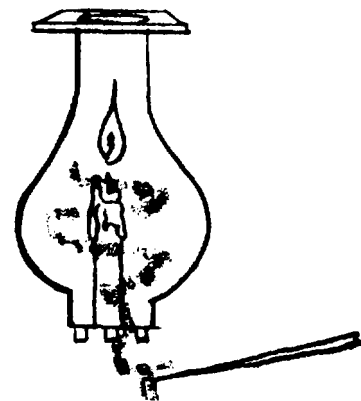

Light the candle and place the chimney over it, resting the chimney on sticks so that air can circulate under the edge. Put the cover glass over the top of the chimney. Light the splinter and hold it near the base of the candle so that smoke will circulate inside the chimney.

Watch the path of the smoke. Remove cover glass and note changes in the path of the smoke. As warm air rises, cold air falls to replace it.

**70.** To show that cold air is heavier than warm air:

Equipment:

- 2 Quart-size, dry, glass jars
- Smoking punk
- Sheet of paper
- Hot water

Put one jar into refrigerator, the other upside down under running hot water.

After a few minutes, remove the jar from the refrigerator. Then let the smoke from punk flow into the cold jar. Immediately cover the jar mouth with a flat piece of paper and place the hot jar over it.

Remove the paper, and watch the path of smoke (convection currents). Keep the jars together, but turn them upside down. Watch the path of smoke as the cold air descends.

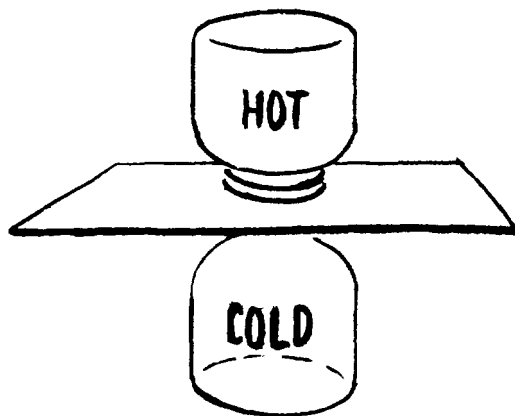

### Wind May Vary in Force

The force of wind is measured in terms of the effects it produces.

**71.** Using a pinwheel such as described on page 6, note whether or not its speed increases as that of the wind striking it increases.

**72.** Look at the school flag outdoors on the pole. It may hang limp when wind of little force is present or be blown about by winds of greater force.

**73.** The force or velocity of the wind is measured by an instrument called the anemometer. Make a simple anemometer.

Equipment:

- Thin sheets of aluminum
- Dowel stock
- 2 glass beads
- 2 thin wooden sticks, 18" x 1/2"
- Aluminum solder

The cups of the anemometer are made from the aluminum. Cut 2 circles about 4" in diameter. Cut these circles in half along the diagonal. Join the straight edges with aluminum solder, making 4 small cups.

Attach the cups to 2 crossed sticks, so that all are heading in the same direction, as illustrated. Join sticks to dowel stock as follows: Nail, bead, crossed sticks, bead, dowel stock. Beads will act as bearings so the wind will turn anemometer freely.

Note that spinning is faster as the force of the wind increases.

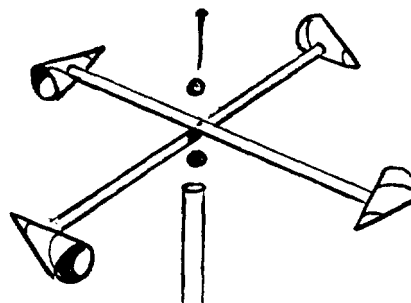

The anemometer may be calibrated with a fair degree of accuracy as follows: Hold it out the window of an automobile moving at a constant rate of speed. Note the speedometer reading and the distance traveled and the revolutions per minute (rpm) of the anemometer. Drive the car back along the same road and note the same readings, being sure the speed of the car and the distance traveled are the same as before. Average the 2 rpm counts to allow for the effect of any wind.

Again drive along the same road the same distance, holding the anemometer out the window of the car, but this time increase the speed to a steady rate 5 or 10 miles an hour faster than before. Repeat in the opposite direction, recording the rpm each time, as was done before, and average them. On the basis of these counts make a table of the anemometer rpm's corresponding to different wind speeds.

## Wind Has Direction

### 74. Make a wind vane.

Equipment:

- Feather
- Straight pin
- Soda straw
- New lead pencil with firm eraser

Insert a 6"-8" feather in one end of the straw, gluing lightly, if desired. Find the balance point by holding the straw on extended finger so it will not tip; insert pin at this point and stick pin into eraser. Vane will move with the wind, always pointing in the direction from which the wind is blowing. Bind the pencil to post outdoors where vane can swing freely.

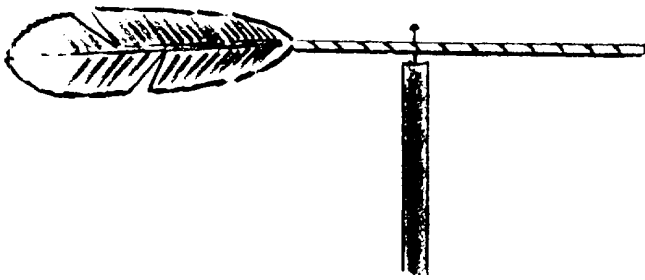

### 75. Make a weather vane.

Equipment:

- Thin wood strips (white pine good):
- 1 20" x 4"
  - 2 12" x 1"
  - 2 8" x 3"
- Long, slender nail  
Small nails  
Wooden or glass bead  
Post about 10' high (or exposed corner of building, such as garage)

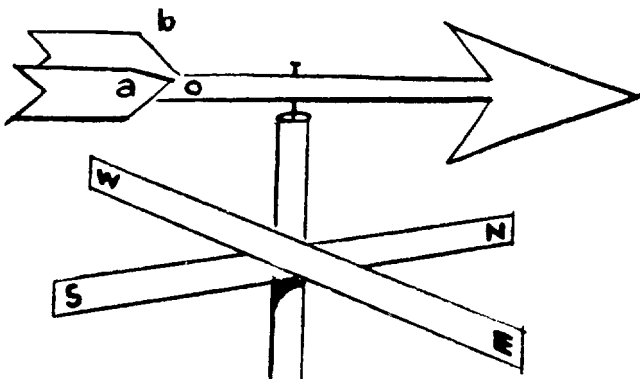

Cut arrow and shaft from 20" strip. Cut tailpieces from 8" strips. Nail them to shaft of arrow on each side; spread them apart to form an angle of 200 in order to catch the wind easily, using a protractor to measure the angle  $AOB$  (see illustration). Find the balance point by resting shaft on extended finger until arrowhead and tailpieces balance level; drill hole at this point. Insert long nail in hole. Place bead on nail to act as bearing. Mount on post, preferably away from buildings.

With compass, determine north. Using the 12" strips, one marked N and S, and the other E and W, as pointers, nail the pointers on the post to show direction from which the wind is blowing. Observe the changes.

### 76. Make a windsock.

Equipment:

- Heavy cloth, about 36" x 24"
- 4 lengths (about 10" each) of heavy wire
- Wire coat hanger
- Stick, about 36" long
- Large nail
- Wooden spool

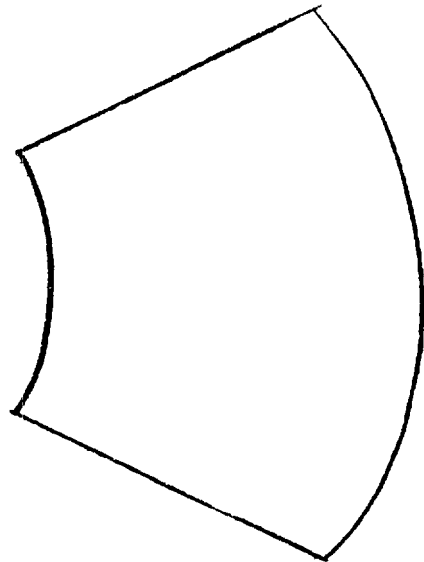

Form the hanger into a loop about 9" in diameter. Attach the 4 wires to this circular loop at 4 equidistant points on its circumference. Cut cloth into a sleeve (see diagram above). Sew sides together, making a cone, and sew larger end of the cone to loop. Bind exposed ends of wires to the spool. Place the nail through the spool so that the spool may pivot freely on the nail, and hammer the nail into the end of the long stick. Place stick outdoors; nail it to a tall post or to a rooftop away from obstructions, so that the sock may swing freely with the wind.

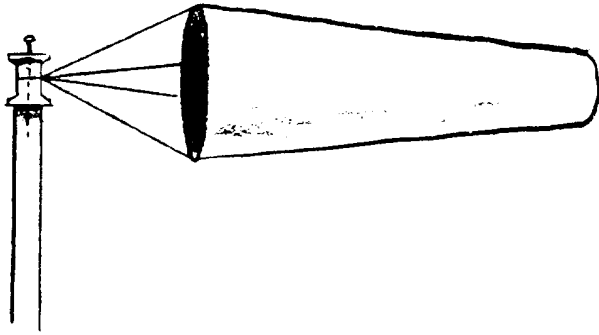

The large end of the sock will catch the wind, so that the small end will point away from the direction from which the wind is blowing, or will droop if there is not enough wind to keep it extended.

Observe the position of the sock at different times for changes in direction and force of the wind.

Windsocks are used chiefly at airports to indicate wind direction for takeoffs and landings. They help the pilot select the proper runway.

## TEMPERATURE

The atmosphere and the earth receive their warmth from the sun. This warmth may vary from place to place and from day to day. The degree of hotness or coldness of the air around us is called temperature.

Temperature affects our activities, the amount of clothing we wear, the kind of outdoor exercise we take and the amount and kind of food and liquid we consume.

### A Thermometer Measures Temperature

77. Make a paper thermometer.

Equipment:

Still white paper about 12" x 3"  
Narrow white ribbon, about 18" long  
Red ink



Dip about half the length of the ribbon into red ink; let it dry. Cut from the center of paper a strip 10" long and the width of the ribbon. Make a cut in the paper  $\frac{1}{2}$ " above and another  $\frac{1}{2}$ " below the space from which the strip was cut; make these gashes slightly longer than the width of the ribbon. Insert the ribbon, with the red half toward the lower end of the paper. Mark the paper in degrees of temperature to cover the range expected in the classroom, or wherever the thermometer will be used, to agree with a real one- say, from 500 to 900. Pull ribbon up or down to register the proper temperature.

78. Make an air thermometer.

Equipment:

Glass bottle, 1-pint size  
Rubber stopper with 1 hole  
Glass tubing to fit hole, 24" long  
Water  
Dye or colored ink  
Sealing wax or paraffin  
Scotch or masking tape  
Cardboard strip, 10" x 2"  
Ordinary thermometer

Place the glass tubing, sealed at one end, through the stopper. Fill the tube full of water colored with the dye. Quickly invert the tube, placing the lower end in a bottle about one-fourth full of the colored water. Press the stopper firmly in the bottle. Adjust the liquid in the tube by loosening the stopper or pressing it further into the bottle until the liquid is about half way along the exposed portion of the tube above the stopper. Then seal with wax the tube in the stopper and the stopper in the bottle. Tape the cardboard to the tube above the stopper.

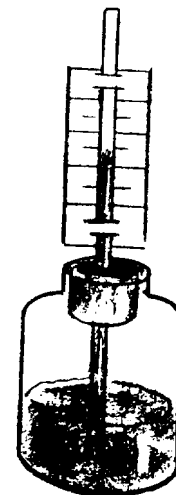

Note the temperature on an accurate thermometer. Record this temperature on the cardboard, which will act as a temperature scale. Place the thermometers in a different temperature situation and leave them for a few minutes to allow the thermometers to register the new temperature. Note the new reading and mark on the scale. Carefully measure the distance between the two readings on the scale, and mark other degrees of temperature on it, as all other changes will be in the same proportion.

### Temperature Helps Determine the State of the Weather

Types of precipitation depend on temperature: rain in warm weather; snow and ice in cold weather.

To find what happens to water when temperature goes below 32° F:

79. Equipment:

- Glass bottle, preferably tall and thin
- Screw cap
- Water
- Masking tape

Fill the bottle to about an inch from the top and mark level on the outside with masking tape. Put bottle outdoors in the shade if the day is very cold- below 32°F. If the day is warmer than 32° F., put the bottle, standing upright, in the freezing compartment of a refrigerator. Observe what happens to the level of water, as ice crystals begin to form in it. Note change in the level when the water is completely frozen.

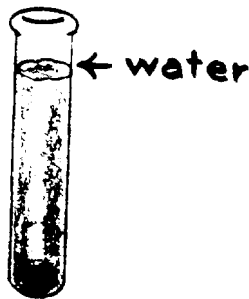

### The Sun Gives Heat

80. Hold one hand in the sunlight and the other in the shade: feel the difference.

81. Observe that other materials give off heat and light under certain conditions.

Feel a candlewick, light a candle. See the flame and feel the heat.

Feel an electric light bulb. Switch the electricity on. See the glow and feel the heat.

Feel a cold steel bar. Place it across a hot flame. See the red- or white-hot glow and cautiously feel the heat.

### The Sun Gives More Heat In Summer Than In Winter

The sun gives more heat in summer because light and heat rays travel in a straight line from their source.

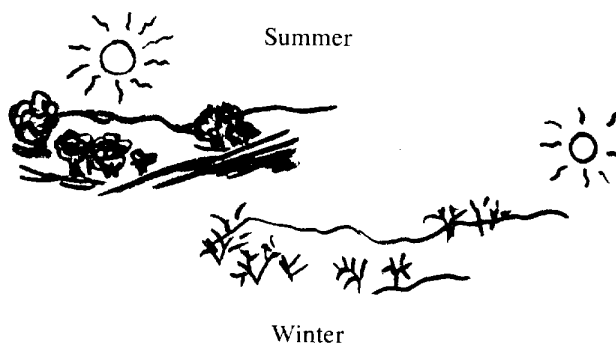

82. To show what happens when light rays strike a surface:

Equipment:

- Flashlight
- Paper tube, large enough to fit around flashlight
- Large sheet of paper
- Table

Lay the paper on a table. Put the paper tube around the flashlight. Turn on the flashlight and direct its rays straight down on the paper. Draw a circle around the outline of light. Notice brightness of reflected light.

Then hold the flashlight at an angle of about 45°. Draw around the light reflected on the paper and notice its brightness. Compare the area of the circle with that of the oval.

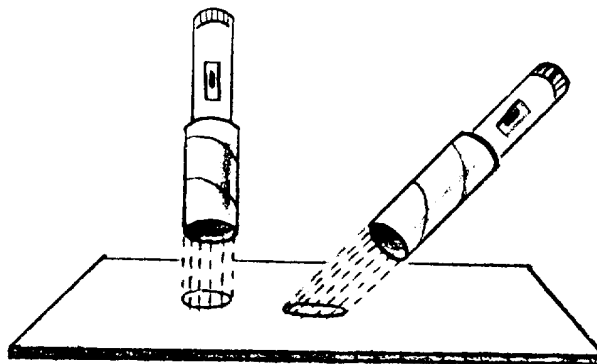

**83.** To show how the angle of the sun's rays affects temperature:

Equipment:

- 2 small boxes filled with sand
- 2 thermometers
- Wooden blocks

Lay a thermometer in each box, with the bulbs lightly buried in the sand. Then put the boxes in the sun for a few minutes. Record the temperatures; they should be the same. Raise one box from the ground by placing small blocks underneath. Tilt the other by placing blocks under one edge of the box, so that the sun's rays fall perpendicular to the thermometer (i.e., strike the thermometer at right angle). Leave the boxes in the sun for a few minutes and then record the temperature.

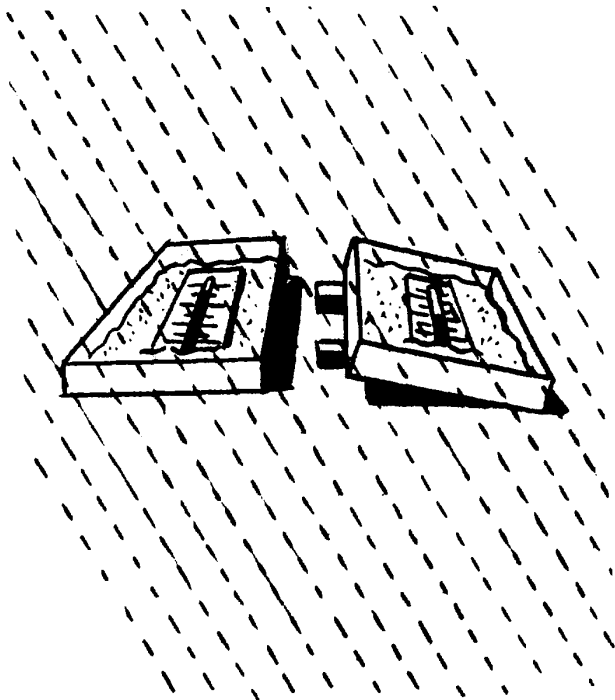

The tilted thermometer records the result of the direct rays of the sun which represent the direct rays of summer. The level thermometer records the angular rays of winter. The tilted thermometer should have a higher reading than the level thermometer. It is possible to obtain a greater contrast of angle, and therefore of temperature readings, when this demonstration is performed in winter.

### The Sun's Heat Varies During the Day

Note that the angle of the sun's rays varies during the day, reaching its largest angle at midday. Remembering

the preceding experiment, you can conclude that the heat received varies also.

**84.** Make a record of thermometer readings in the shade at regular intervals during the day. Note that as the sun's rays increase the heat around us, the liquid in the thermometer expands and rises; note that as night approaches the temperature begins to fall.

**85.** Place one thermometer in the sun, another in the shade. Record the readings of each at regular intervals during the day.

**86.** The density of the liquid in a thermometer varies with the temperature around the bulb. Place thermometers in such places as a dish of ice water, outdoors on a cool day and on a warm day, indoors on a very cold day, in the sun, in the shade, over a radiator, in hot water, in your armpit, in the refrigerator, and near a glowing electric light bulb.

### The Temperature Changes With the Seasons

Seasonal changes in temperature are the result of changes in the amount of heat received by the earth from the sun.

Note the position of the winter sun fairly low in the sky even at midday in temperate zones, accompanied by long shadows and with little warmth. Compare these conditions with those of the other seasons (see Nos. 82, 33).

Shadows change in length and position as the sun appears to move in an arc across the sky.

**87.** Make a shadow stick.

Equipment:

- 3" nail
- Board about 10" square

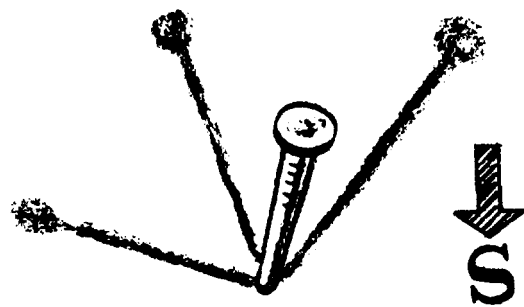

Put nail in the board centered near one edge. Mark an S at edge of board in front of the nail. Place the board in a spot which will have sun all day, being sure that the edge of the board with the S and the nail are facing south. Mark along the line of shadow every hour on the hour.

88. Observe your own shadow at different times of the day and during different days of the season.

89. Observe the shadow of the school flagpole.

90. If a school window sash makes a pattern on the floor, draw, with chalk, outlines of the pattern on the floor at intervals of an hour or so, and note the apparent path of the sunlight.

91. Fun with shadows: make shadow pictures against a light-colored wall or screen. If there is no sunlight, use another source of light, such as a bright lamp or a projector.

92. Note that shadows disappear on a cloudy day.

### The Sun Gives Light Day and Night

It is shining all the time on some part of the earth. When we look at the moon we see reflected sunlight.

### 93. Equipment:

- Globe of the world
- Flashlight

Point the lighted flashlight in the direction of New York City on the globe. This side of the globe represents daylight; the opposite or dark side represents nighttime. (When it is 12 noon in New York City, it is midnight in Bangkok, Thailand.) Turn the globe so that the positions of New York City and Bangkok are reversed. What time is it in Bangkok? In New York City?

If a globe is not available, mark approximate positions of these two cities on a basketball, grapefruit, or balloon.

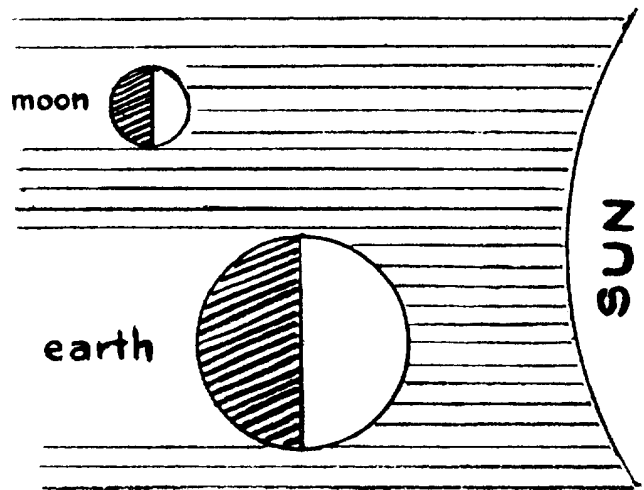

### Comparative Time

NEW YORK  
NOON

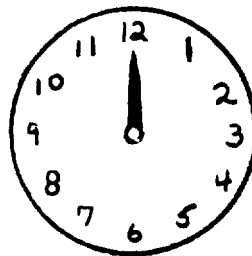

BERLIN  
PM

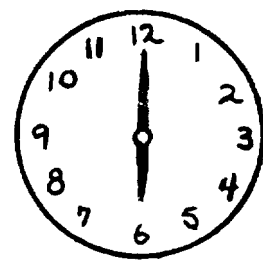

SAN FRANCISCO  
AM

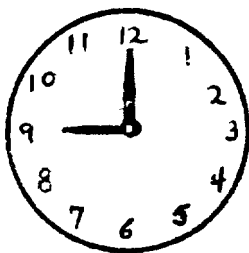

BANGKOK  
MIDNIGHT

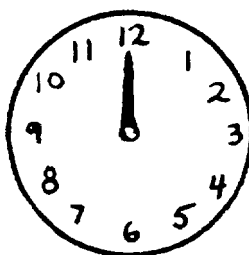

YOKOHAMA  
AM

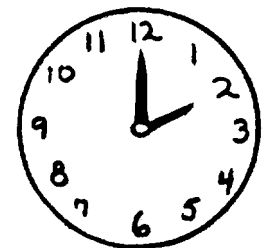

#### 94. Equipment:

- 5 pieces of cardboard, 8" x 12" (cardboard inserted in laundered shirts are good)
- Cardboard, to make hour and minute hands
- Thumbtacks
- Masking tape, light colored
- Red and black crayon

Draw circle and numerals on each 8" x 12" cardboard to resemble the face of a clock. Cut out minute and hour hands, color them, and attach a set to each clock by means of a thumbtack. Label clocks: New York, New York; San Francisco, California; Berlin, Germany; Bangkok, Thailand; and Yokohama, Japan.

Make small signs to show daylight and nighttime, using the masking tape and lettering the AM and Noon signs in red crayon and the PM and Midnight signs in black. (See p. 27)

Set the clocks as follows: New York at 12 noon; San Francisco, 9 a.m.; Berlin, 6 p.m.; Bangkok, 12 midnight; and Yokohama, 2 a.m. (the next day). Attach the masking tape signs above the faces of the clock. Note in what parts of the world it is daylight and where it is nighttime. Then move all clocks ahead 3 hours; 6 hours; 12 hours; each time be sure to change the AM and PM signs.

### MOISTURE IN THE AIR

#### Humidity

*Humidity* is the amount of moisture in the air. (See pp. 7, 8.)

*Relative humidity* is the amount of moisture in a given body of air compared with the amount it is capable of holding at the prevailing pressure and temperature conditions.

Relative humidity is determined with the help of a wet and dry bulb thermometer or a slingpsychrometer.

#### 95. Equipment:

- 2 thermometers, matched for accuracy
- Board large enough to hold both thermometers nailed side by side on it
- Cotton bag or wick to fit tightly over I bulb
- Wooden spool
- Long bolt and nut

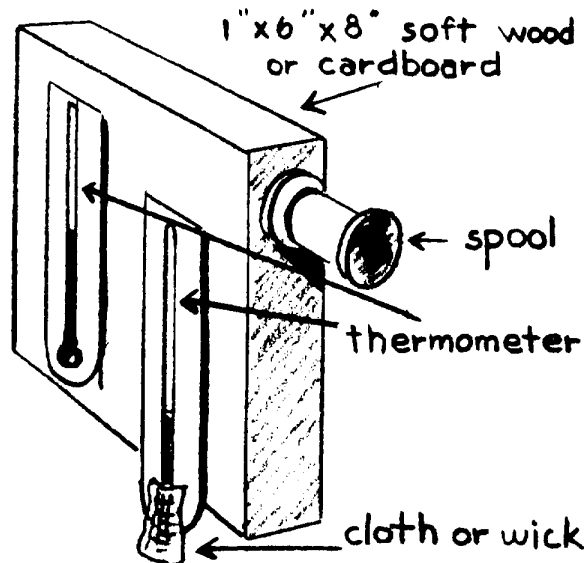

To make a sling psychrometer, remove the metal guard from one thermometer and cover its bulb tightly with the cloth or wick. Nail both the thermometers onto the board. Using the nut and bolt, attach the spool to the upper corner of the board, so that it will rotate freely.

Dip the cloth in water. Hold the spool and whirl it rapidly above your head. Record the temperature observed on each thermometer. The wet bulb should read the lower.

From the relative humidity chart, determine the relative humidity, using the readings of both thermometers.

#### HOW TO USE CHART:

When wet-and-dry bulb thermometer readings are known, find intersection of the two solid temperature lines. At this spot read relative humidity on long-dotted lines and dew points on short-dotted lines.

For example, if air temperature is 85° and wet bulb temperature is 75°, their intersection point on the chart shows the relative humidity to be about 63%, and the dew point to be about 71°.

To use the sling psychrometer you have made as a stationary wet and dry bulb thermometer, put a small bottle containing water under the wet bulb and let a length of cloth hang down into the bottle so that the cloth remains wet. When ready to take readings, use the relative humidity chart as before.

#### Dew Point

Dew point is the temperature at which the air becomes saturated with water vapor and the relative humidity becomes 100 percent.

## CHART TO DETERMINE RELATIVE HUMIDITY AND DEW POINT

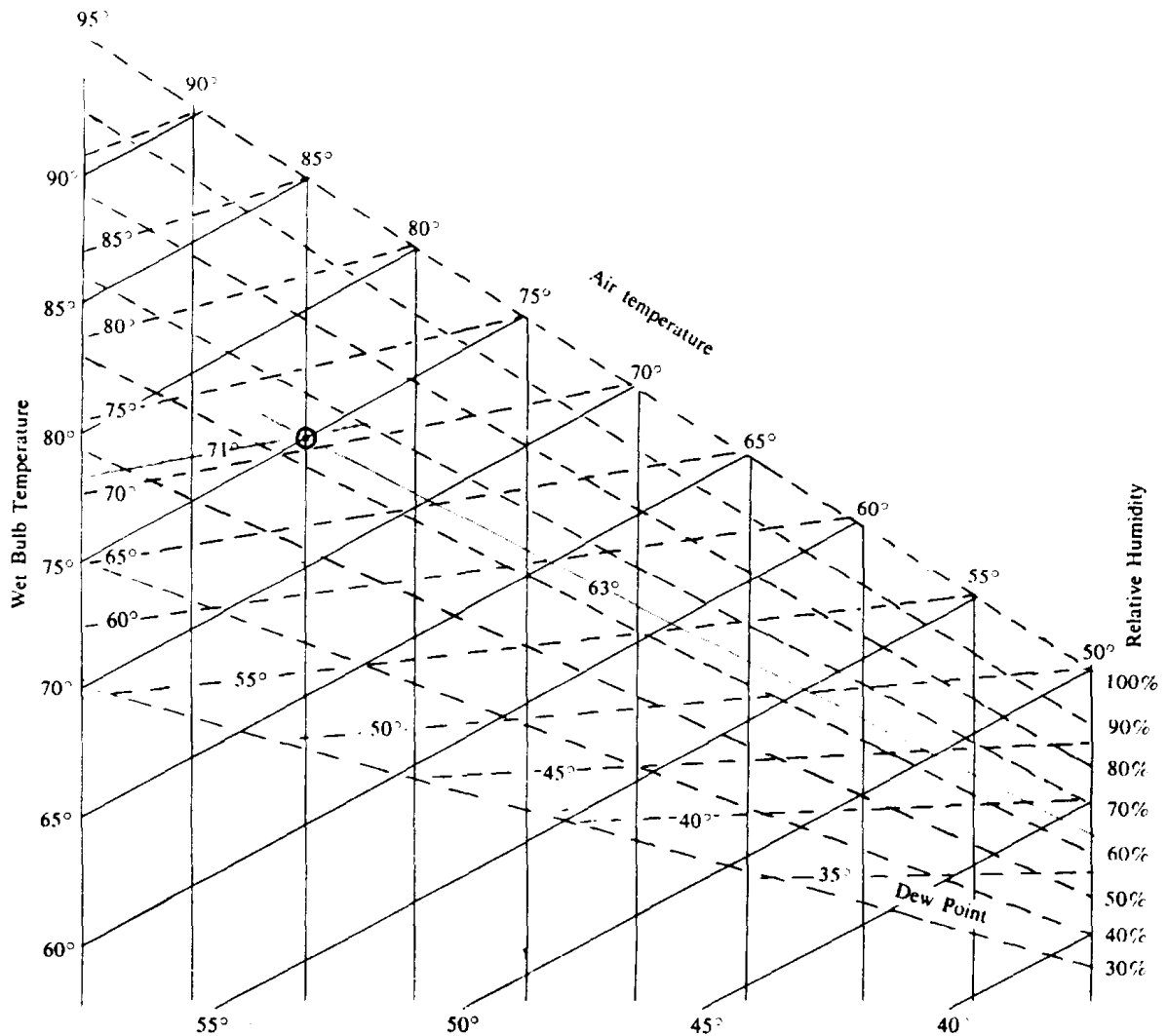

96. To determine the dew point:

Equipment:

- Polished aluminum water glass
- Crushed ice or small ice cubes
- Room thermometer
- Water

Fill the glass one-half full of water at room temperature, making sure that the glass is dry on the outside. Put the thermometer into the glass. Add ice slowly, carefully noting changes in the temperature of the water and watching for condensation (tiny drops of water) to occur on the outside of the glass. The

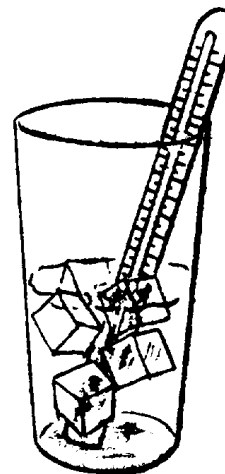

temperature at which condensation begins is the dew point.

Repeat the experiment, using dry ice (CO<sub>2</sub>) instead of ice cubes, and note "frost" forming on the outside of the glass.

Repeat on different days, and record.

Cool air can hold less water vapor than the same volume of warm air. If saturated air is cooled below the dew point, condensation occurs.

**97.** To produce and observe the phenomenon of condensation of water vapor, make a Wilson Cloud Chamber.

Equipment:

- Carton. about 20" x 20" x 10"
- Tall jar with straight sides, such as large size peanut butter jar
- Coffee can, 1-pound size, clean and empty
- Piece of thick felt, cut slightly smaller than the coffee can
- Box or block to support the jar
- 5 pounds of dry ice
- Hot water
- Large sheet of black construction paper
- Filmstrip projector
- Masking tape

Cut a hole in the top of the carton into which the jar exactly fits. Put the dry ice into the carton. Put a support under the hole and place the jar on it, so that about an inch of the jar is within the carton. Put masking tape around the jar so that no air can pass around it, into or out of the carton.

Place the paper behind the jar and carton so that it can be seen through the jar. Set up the projector so that the beam passes through the jar horizontally.

Glue the felt to the underside of the coffee can. Soak the felt. Fill the coffee can almost full with very hot water. Place the can on the jar, with the felt pressing on the jar's edge. (See diagram.)

Observe condensation: water vapor will form into clouds, and convection currents will cause them to circulate within the jar, the cold air rising along its sides and the warm air descending at its center. When the vapor clings to particles of dust within the jar, the falling of "brain" is visible. After about 20 minutes, when the water in the jar has changed to ice at its bottom, it is possible to see streaks within the jar. These streaks are cosmic rays.

**98.** Detecting moisture in the air with a hair hygrometer:

Equipment:

- Empty milk carton
- Large sewing needle
- Broom straw, 2" long
- Scotch or masking tape
- Penny
- 9" human hair wiped clean of oil
- 4 thumbtacks
- Paper clip
- Dishpan

Cut the carton so as to make a small horizontal slit near the top; insert the paper clip. (Fig. 1.)

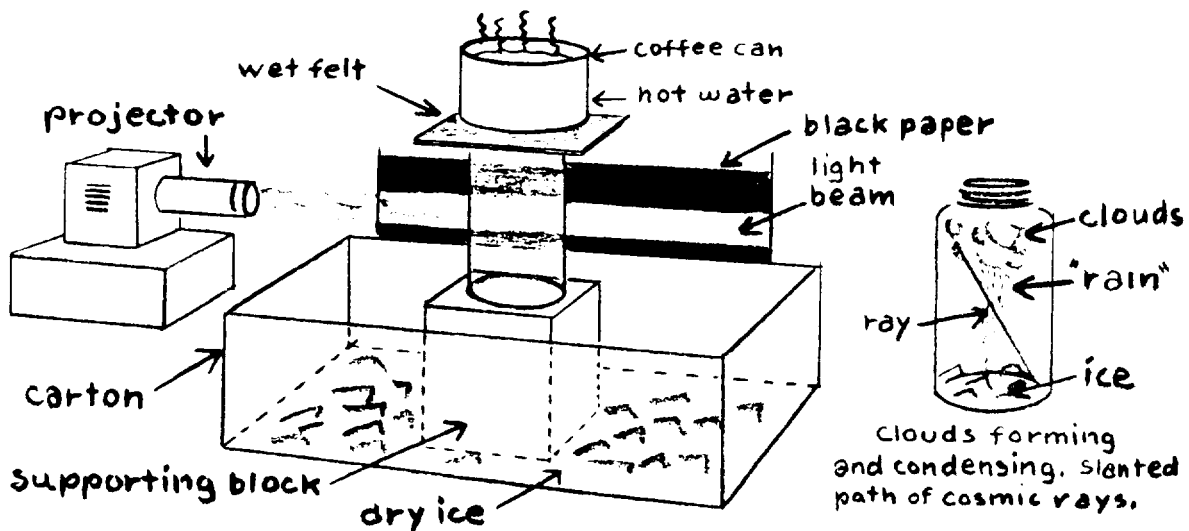

Cut a vertical slit near the bottom. Then cut horizontal slits perpendicular to this cut at its end points-like an H on its side. (Fig. 1.)

Pry out the flaps thus made and bend them to an upright position. Insert the needle through these flaps. (Fig. 2)

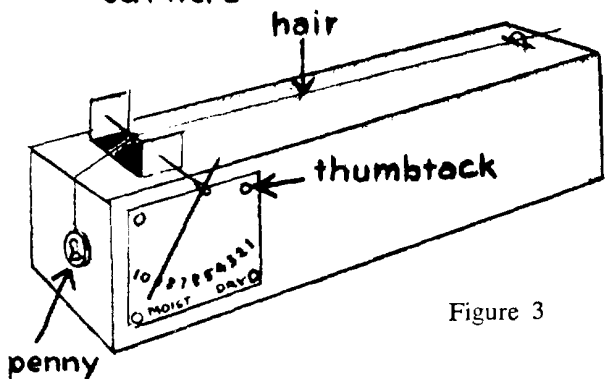
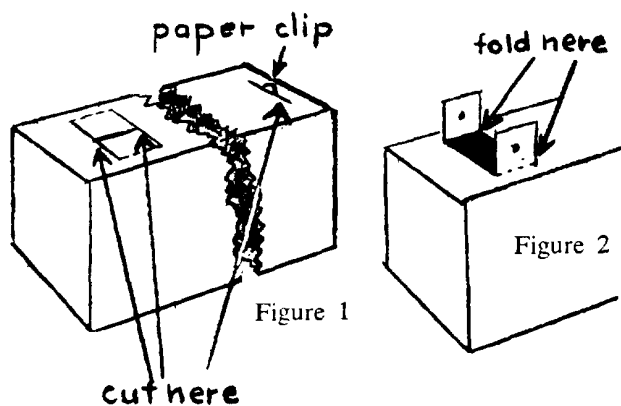

Tie the hair to the paper clip, wind it around the needle, tape the penny to the other end of the hair, and let the penny hang over the end of the box, which should be lying on its side.

Put a card with a scale on the side of the carton under the straw which has been pushed through the eye of the needle. (Fig. 3)

Place the hygrometer on a wet towel in a dishpan and cover with a damp cloth. After 15 minutes remove it from the cloths and set the straw at numeral 10 on the scale. Watch to see whether the straw moves.

Since humid air causes the hair to stretch and dry air causes it to shrink, the straw should move toward the dry end of the scale as the hair dries.

## Evaporation

When water evaporates it becomes vapor, taking heat from materials around it in the process.

99. Wet your hands. Note that they feel cool while the water on them is drying (i.e., evaporating).

### 100. Equipment:

2 glass jars, the same size  
Masking tape

Fill 2 clean jars with the same amount of water. Cover one of the jars tightly. Put the jars in a conspicuous place where they will remain undisturbed. Put a strip of masking tape at the water-level line of each jar. Observe them at regular intervals for several days and again mark the water levels.

The water evaporated mixes with air as water vapor; it is invisible. The water cycle usually is as follows: water-vapor, clouds, and rain.

## ATMOSPHERIC PRESSURE

The body of air which surrounds the earth is called atmosphere. Since air itself exerts pressure (pp. 3, 4 & 5), the pressure of the air surrounding the earth is referred to as atmospheric pressure.

At sea level, air exerts a pressure of 14.7 pounds per square inch, but a cubic yard of it weighs only about 2 pounds.

101. Atmospheric pressure is measured by a *barometer*.

### Equipment:

Small glass or beaker  
Glass barometer tube 36" long, closed on one end  
Mercury  
Ring stand with clamp  
Cardboard strip, 2" x 10"  
Scotch or masking tape  
Yardstick

Pour the mercury into the barometer tube, filling it completely. Pour the remaining mercury into a beaker. Place a finger over the open end of the tube and invert the tube, lowering it carefully into the beaker containing the remainder of the mercury. Clamp the tube upright on the stand.

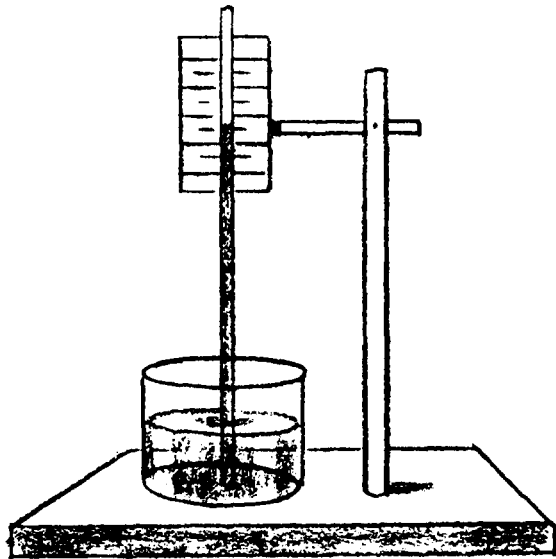

Mark a scale of inches and half inches on the cardboard, and label it from 24 to 36 inches. With the yardstick, measure the actual height of the mercury column and attach the scale to the proper spot on the tube.

Watch the day-to-day variations in the height of the mercury. Record readings of these. Compare them with radio and newspaper reports of local barometric pressure conditions.

**NOTE:** Be very careful that the mercury does not come in contact with any jewelry you may be wearing.

**102.** The deeper water or air gets, the greater the pressure becomes.

Equipment:

Large fruit-juice can  
Ice pick

Puncture several holes of the same size, at different levels, in the side of a large fruit-juice can. Notice the weakness of force with which water escapes from the upper holes. The ones near the bottom, with the greater height of water above them, have water shooting out at some distance.

Watch what happens as the water runs out and the level of the water lowers. Do all the streams run with less force than they did at the start?

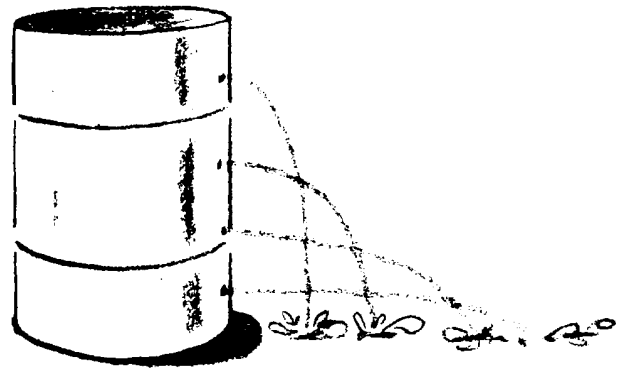

**103.** Make a siphon.

Equipment:

2 identical glass jars  
Rubber tubing  
Wooden block, 2" thick

Fill one jar with water. Put jars side by side on a table. Fill tube with water, close one end with your finger, and lower the other end into the water in the jar before removing finger. Watch what happens to the level of water in each jar.

Raise one jar by putting the block under it. Again watch water levels. The water remains at the same height in each jar regardless of the difference in height of the jars, because the atmospheric pressure is the same on the water surfaces in each jar.

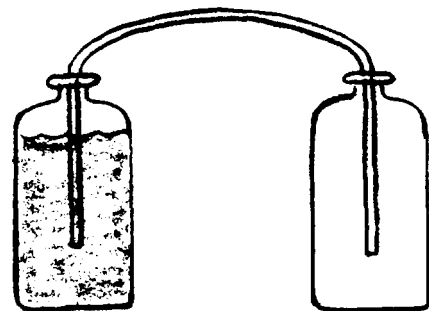

**104.** To show that air moves from a high to a low pressure area:

Equipment:

Heavy glass tube, about 6" long and 1" in diameter  
2 toy balloons of the same size

Place one balloon over one end of the tube. Inflate the other balloon and, holding the neck of the balloon tightly to avoid losing air, slip it over the other end of the tube. Release the neck and observe results.

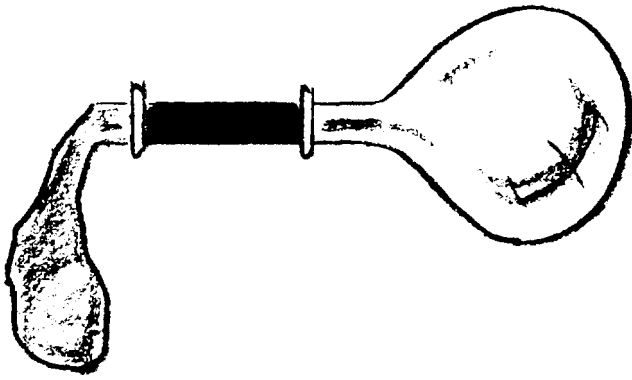

Air rushes from the inflated balloon to the empty balloon. When the air pressures inside the two balloons become equal, the air stops moving from one to the other. Are they now the same size?

**105.** The principles learned about air pressure are put to work in modern instruments, such as the *manifold pressure gauge* used in aircraft. Make a simple manifold pressure gauge:

Equipment:

- Small jar
- Rubber from a balloon
- Short soda straw
- Model airplane glue
- Very large jar, with a screw cap
- Length of rubber hose
- Scotch or masking tape

Cover the small jar tightly with the rubber. Glue soda straw to it so that one end of the straw is in the center of the jar's top. Put the small jar into the larger one. Puncture the lid of the large jar with a nail, forming holes in a circular pattern the size of tee rubber hose. Punch out this pattern. Insert the hose in the hole thus formed and, with tape, seal any space where the hose enters the screw top.

Blow through the tube (the manifold pressure increases) and notice how the straw moves up because pressure on the small jar increases. If air is sucked out of the tube, the straw should move down, because the pressure on the small jar decreases while the pressure within it remains the same.

